

LITTLE LEAGUE® BASEBALL AND SOFTBALL
RULES INSTRUCTION MANUAL
PREPARED FOR THE 2018 LITTLE LEAGUE UMPIRE SCHOOLS



INCLUDES SUBSTANTIAL INFORMATION FROM
THE FOLLOWING PUBLICATIONS:

"2018 LITTLE LEAGUE BASEBALL® OFFICIAL REGULATIONS AND PLAYING RULES"

"2018 LITTLE LEAGUE SOFTBALL® OFFICIAL REGULATIONS AND PLAYING RULES"

"2018 LITTLE LEAGUE CHALLENGER DIVISION® OFFICIAL REGULATIONS AND PLAYING RULES"

"THE RIGHT CALL - CASEBOOK OF LITTLE LEAGUE BASEBALL"

PREPARED BY LITTLE LEAGUE® INTERNATIONAL



LITTLE LEAGUE® UNIVERSITY TRANSFORM THE WAY YOU TRAIN

LITTLE LEAGUE VOLUNTEERS, ADMINISTRATORS, COACHES, AND PARENTS
EXPERIENCE AND LEARN ABOUT THE LITTLE LEAGUE PROGRAM.

Our free online training, LittleLeagueU.org, connects visitors to engaging training videos and informative how-to articles, designed to educate users on the best practices for operating and enjoying a successful local Little League experience in your community.

This easy-to-navigate portal features customized instruction, an assortment of practice plans, and interactive quizzes for everyone involved in Little League, including District Administrators, League Presidents and local board members, umpires, coaches, and parents.

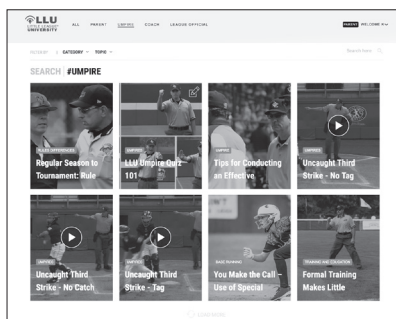

UMPIRES

- “Basic 6,” home plate and base mechanics
- Positioning instruction for two-, three-, four-umpire crews
- Situational case studies
- Umpire-In-Chief recruitment, training, and evaluation
- Best practices for pre-and post-game conferences

2018 RULES INSTRUCTION MANUAL

TABLE OF CONTENTS

OFFICIAL REGULATIONS	I
REGULATION I – THE LEAGUE	I
REGULATION III – THE TEAMS	I
REGULATION IV - THE PLAYERS	I
REGULATION VI - PITCHERS	2
REGULATION VI - PITCHERS (MINOR & MAJOR SOFTBALL)	4
REGULATION XIV - FIELD DECORUM	6
OFFICIAL PLAYING RULES	
RULE 1.00 — OBJECTIVES OF THE GAME	7
RULE 2.00 — DEFINITION OF TERMS	17
RULE 3.00 — GAME PRELIMINARIES	26
RULE 4.00 — STARTING THE GAME	31
RULE 5.00 — PUTTING THE BALL IN PLAY - LIVE BALL	39
RULE 6.00 — THE BATTER	42
RULE 7.00 — THE RUNNER	50
RULE 8.00 — THE PITCHER (BASEBALL)	62
RULE 8.00 — THE PITCHER (SOFTBALL)	68
RULE 9.00 — THE UMPIRE	72

PLEASE REMEMBER

- Rules are generally listed as they appear in one of the respective rules books, with Rule Numbers listed in bold type, with Rules Numbers listed in bold type.
- [Programs listed are **Challenger, Tee Ball, Minor, Major, Intermediate (50/70) Junior, Senior League.**]
- [Variances in the **Little League Baseball®, Little League Softball® and Little League Challenger Division®** programs are also included.]
- For rule, regulation, and policy updates throughout the year visit LittleLeague.org/Rules.
- Significant changes will be identified by this shaded background
- * Indicates change after the printed Rulebooks, by the International Board of Directors at Little League Congress
- Umpire Notes will be identified by this shaded background

A.R.—An Approved Ruling (A.R.) serves to illustrate the application of the regulations and rules. Approved Rulings follow the regulations and rules they amplify and are indicated by a box

INSTRUCTORS COMMENTS

- ➔ These notes are not part of any Rulebook publication, but are helpful comments or explanations from Little League International.
 - ➔ Included in this section will be rule interpretations, basic mechanics instruction, and appropriate suggestions.
- EXAMPLES:** Showcase game plays for the ruling above.

- **NOTE:** The use of “he/she” for Baseball participants and “she” for Softball participants does NOT preclude either gender from a program. Exception: In girls’ softball, only girls are eligible. In boys’ softball, only boys are eligible.

This publication is to be used solely as a training aid and in NO way will the information presented here be used in lieu of or to supplant the Official Little League Rulebooks.

LITTLE LEAGUE REGULATIONS

REGULATION I – THE LEAGUE

Consult appropriate Little League rulebook for additional information.

(c) 9 Note 1: Information regarding background checks is available at LittleLeague.org/background. Information gathered for background checks and results should be considered confidential, protected from public disclosure, and not used for any purpose beyond determining volunteer eligibility.

REGULATION III – THE TEAMS

(d) Note 3: If a medical professional, Umpire in Chief, the player's coach, the player's manager or the player's parent has determined a player sustains a possible concussion, the player must be, at a minimum, removed from the game and/or practice for the remainder of that day. The league must also be aware of its' respective state/provincial/ municipal laws with regards to concussions and impose any additional requirements as necessary. His/her return to full participation is subject to 1.) The leagues' adherence to its respective state/provincial/municipal laws 2.) An evaluation and a written clearance from a physician or other accredited medical provider and 3.) Written acknowledgment of the parents.

Little League International strongly encourages all leagues and teams to not only comply with any applicable state/provincial/municipal laws, but also, to review the information and training materials on concussions that are available free of charge on the Centers For Disease Control website, accessible at LittleLeague.org/concussions. This link also provides concussion information from all 50 states.

INSTRUCTORS COMMENTS

→ It is strongly recommended that all umpires go on the Center for Disease Control (CDC) website and take the concussion course so that they can familiarize themselves and be able to recognize the symptoms of a concussion and what to do if the situation should occur. It doesn't seem that concussions occur as frequently in baseball and softball as it does in other sports but you need to be prepared if it does occur.

REGULATION IV - THE PLAYERS

(a) **Tee Ball Division:** Any candidate who will attain the age of 4 years before September 1 and who will not attain the age of 8 before August 31 of the year in question shall be eligible to compete in the Tee Ball Division Baseball (subject to the Local League Board of Directors alignment of this division)

NOTE: If a league elects to operate a Tee ball baseball program only, it must use league age determination date noted above.

(a) **Junior League:** During International Tournaments, a player deemed ineligible under this rule is subject to removal and his/her team is subject to forfeiture by action of the Tournament Committee.

All MINOR, MAJOR, INTERMEDIATE (50/70) BASEBALL, JUNIOR & SENIOR BASEBALL & SOFTBALL Programs:

(i) **Mandatory Play:** Every rostered player present at the start of a game will participate in each game for a minimum of six (6) defensive outs and bat at least one (1) time. For the purpose of this rule, "six defensive outs" is defined as: A player enters the field in one of the nine defensive positions when his/her team is on defense and occupies such position while six outs are made; "bat at least one (1) time" is defined as: A player enters the batter's box with no count and completes that time at bat by being put out, called out by an umpire or by reaching base safely.

INSTRUCTOR COMMENTS:

→ This now defines what constitutes the requirements of mandatory play. Under 3.03, a starter does not have to play a defensive position for six "consecutive" defensive outs because he/she has reentry rights but he/she MUST get six defensive outs sometime during the game. A substitute MUST get six "consecutive" defensive outs before he/she is removed from the game because he/she does not have reentry rights.

→ To qualify as a time at bat for this rule, the batter MUST complete a time at bat by stepping into the batter's box with no count and completing the time at bat by being put out; reaching base safely or being called out by an umpire. If a Rule 6.07 violation (Batting Out of Order) is discovered before a batter has completed his/her time at a bat and the proper batter replaces the improper batter who had a count on him/her, neither player has met the requirements of this rule for mandatory play and both players will have to complete a time at a bat sometime later in the game. If a player/batter is called out by an umpire for using an illegal bat or for Rule 6.07 violation, this will qualify as an at bat for the purpose of this rule

PENALTY: The player(s) involved shall start the next scheduled game, play any previous requirement not completed for Section (i) and the requirement for this game before being removed.

The manager shall for the:

- A. First Offense - receive a written warning.
- B. Second Offense - a suspension for the next scheduled game.
- C. Third Offense - a suspension for remainder of the season.

NOTE 1: If the violation is determined to have been intentional, a more severe penalty may be assessed by the Board of Directors. However, forfeiture of a game may not be invoked.

NOTE 2: There is no exception to this rule unless the game is shortened for any reason at which time the Local League may elect not to impose a penalty on the manager/coach. However, the penalty in this regulation regarding the player who did not meet mandatory play cannot be reduced or waived in a shortened game

NOTE 3: In Minor League, if a half-inning ends because of the five-run limit in “Rule 2.00 – Inning,” and a player on the defense has played for the entire half-inning, that player will be considered to have participated for three consecutive defensive outs for the purposes of this rule. However, if the player has not played on defense for the entire inning, that player will be credited only as having played for the number of outs that occurred while the player was used defensively.

Tee Ball and Minor League: If a league uses 15 to 20 player rosters they may reduce the Mandatory Play Rule to three (3) defensive outs and one (1) at bat per game.

A.R.—If a player/batter is called out by an umpire for using an illegal bat or for Rule 6.07 violation, this will qualify as an at bat for the purpose of this rule.

EXAMPLE 1: Sean is a starter and plays inning #1. The manager takes Sean out of the game after one full inning and substitutes Andrew. Andrew plays the 2nd, 3rd, and 4th innings and bats twice. In the 5th inning the manager puts Sean back into the game. Sean bats and plays the 5th and 6th innings. **Ruling:** *It is not mandatory that a starter plays six consecutive defensive outs and bats once, before he/she is substituted for. A starter may re-enter after his/her substitute has played at least six consecutive outs and batted once.*

EXAMPLE 2: In the top of the 4th inning, Miranda is substituted for Sabrina. In the bottom of the 4th, with the home team winning, rain comes and the game is official and declared over. **Ruling:** *No penalty is assessed to the manager for not playing everyone six outs and one at bat. The game was ended by conditions the manager had no control over. The same ruling would apply to games shortened by darkness, light failure or time limit. However, any player who did not meet the mandatory play rule requirement, shall start the next game and play six consecutive outs and one at bat along with what he/she missed in the previous game before being replaced.*

INSTRUCTOR COMMENTS:

- ➔ Responsibility for insuring that the Manager adheres to the elements of this rule rests with the Board of Directors. Every effort should be made to insure that players play the appropriate amount of time.
- ➔ This rule cannot be protested. Don't penalize the players for the incorrect actions (or lack of action) by the Manager.
- ➔ If a game is shortened for any reason, the manager may not be held responsible unless his/her actions were intentional. However, the Board is still responsible for insuring the players fulfill their playing requirements.

REGULATION VI - PITCHERS (BASEBALL)

- (a) Any player on a regular season team may pitch. **Exception:** *any player, who has played the position of catcher in four (4) or more innings in a game, is not eligible to pitch on that calendar day.*

A.R. — The catcher receiving one pitch to a batter in the fourth inning constitutes having caught four (4) innings. Warm-up pitches do not count, only when the ball is live will the pitches count toward innings caught

INSTRUCTOR COMMENTS:

- ➔ The responsibility and compliance of this rule belongs to the manager of the team. The enforcement however belongs to the umpires and they should always be aware of player substitutions for catcher's and pitchers.
- ➔ The catcher receiving one pitch to a batter in the fourth inning constitutes having caught four (4) innings. Warm-up pitches do not count, only when the ball is live will the pitches count toward innings caught.

[CHALLENGER: Although use of the batting tee or coach pitch is strongly recommended, any player on the roster may pitch.]

- (b) A pitcher once removed from the mound cannot return as pitcher. (**Intermediate 50/70, Junior, Senior League Divisions only:** A pitcher remaining in the game, but moving to a different position, can return as a pitcher anytime in the remainder of the game, but only once per game.)

INSTRUCTOR COMMENTS:

- ➔ Note the wording: “but only once per game.” (**Intermediate (50-70) Junior/Senior League Baseball**) can still move a pitcher to another position (remaining in the game) and bring him/her back to pitch later but only one time during that entire game

- (c) The manager must remove the pitcher when said pitcher reaches the limit for his/her age group as noted below, but the pitcher may remain in the game at another position:

League Age	
13-16	95 pitches per day
11-12	85 pitches per day
9-10	75 pitches per day
7-8	50 pitches per day

EXCEPTION: If a pitcher reaches the limit imposed in Regulation VI(c) for his/her league age while facing a batter, the pitcher may continue to pitch until any one of the following conditions occurs. Note: A pitcher who delivers 41 or more pitches in a game cannot play the position of catcher for the remainder of that day. Umpires must remain aware of which players are occupying the positions of pitcher and catcher.

1. That batter reaches base;
2. That batter is put out;
3. The third out is made to complete the half-inning.

(NOTE: A pitcher who delivers 41 or more pitches in a game cannot play the position of catcher for the remainder of that day. Umpires must remain aware of which players are occupying the positions of pitcher and catcher.)

- (d) Pitchers league age 14 and under must adhere to the following rest requirements:
- If a player pitches 66 or more pitches in a day, four (4) calendar days of rest must be observed.
 - If a player pitches 51 - 65 pitches in a day, three (3) calendar days of rest must be observed.
 - If a player pitches 36 - 50 pitches in a day, two (2) calendar days of rest must be observed.
 - If a player pitches 21 - 35 pitches in a day, one (1) calendar days of rest must be observed.
 - If a player pitches 1-20 pitches in a day, no (0) calendar day of rest is required.

*** NOTE:** Under no circumstance shall a player pitch in three (3) consecutive days.

EXCEPTION: If a pitcher reaches a day(s) of rest threshold while facing a batter, the pitcher may continue to pitch until anyone of the following conditions occur: (1) That batter reaches base; (2) That batter is retired; or (3) The third out is made to complete the half-inning. The pitcher will only be required to observe the calendar day(s) of rest for the threshold he/she reached during that at-bat, provided that pitcher is removed before delivering a pitcher to another batter.

Pitchers league age 15-16 must adhere to the following rest requirements:

- If a player pitches 76 or more pitches in a day, four (4) calendar days of rest must be observed.
- If a player pitches 61 - 75 pitches in a day, three (3) calendar days of rest must be observed.
- If a player pitches 46 - 60 pitches in a day, two (2) calendar days of rest must be observed.
- If a player pitches 31 -45 pitches in a day, one (1) calendar days of rest must be observed.
- If a player pitches 1-30 pitches in a day, no (0) calendar day of rest is required.

*** NOTE:** Under no circumstance shall a player pitch in three (3) consecutive days.

EXCEPTION: If a pitcher reaches a day(s) of rest threshold while facing a batter, the pitcher may continue to pitch until anyone of the following conditions occur: 1. That batter reaches base; 2. That batter is retired; 3. The third out is made to complete the half-inning. The pitcher will only be required to observe the calendar day(s) of rest for the threshold he/she reached during that at-bat, provided that pitcher is removed before delivering a pitch to another batter

INSTRUCTOR COMMENTS:

- ➔ This exception will now allow a pitcher to finish pitching to a batter while exceeding his/her pitch count limit threshold for a particular day(s) of rest requirement. This exception will only take place providing he/she reaches that threshold during that player's at-bat and that the pitcher does not start the at-bat at the limit for that threshold. This will make it easier on the teams so that they will not have to remove the pitcher for a relief pitcher in the middle of an at-bat, which can be a disadvantage for a pitcher coming who is not properly warmed up.

- (e) Each league must designate the scorekeeper or another game official as the official pitch count recorder.

INSTRUCTOR COMMENTS:

- ➔ The "official pitch count recorder" can be the scorekeeper, a separate individual to just keep track of pitches, the home team manager/coach, but someone must be designated to keep track.

- (f) The pitch count recorder must provide the current pitch count for any pitcher when requested by either manager or any umpire. However, the manager is responsible for knowing when his/her pitcher must be removed.
- (g) The official pitch count recorder should inform the umpire-in-chief when a pitcher has delivered his/her maximum limit of pitches for the game, as noted in Regulation VI (c). The umpire-in-chief will inform the pitcher's manager that the pitcher must be removed in accordance with Regulation VI (c). However, the failure by the pitch count recorder to notify the umpire-in-chief, and/or the failure of the umpire-in-chief to notify the manager, does not relieve the manager of his/her responsibility to remove a pitcher when that pitcher is no longer eligible.
- (h) Violation of any section of this regulation can result in protest of the game in which it occurs. Protest shall be made in accordance with Playing Rule 4.19.
- (j) A player who has attained the league age of twelve (12) is not eligible to pitch in the Minor League. **(See Regulation V – Selection of Players)**
- (k) A player may not pitch in more than one game in a day:

Minor League, Little League and Intermediate (50/70) Division-A player may not pitch in more than one game in a day;

Junior League and Senior League-A player may be used as a pitcher in up to two games in a day. **(Exception: If the player pitched 31 or more pitches in the first game, that player may not pitch in the second game of that day);**

A.R.—If a **Junior or Senior League** pitcher pitches in more than one game in a day, and has not pitched 31 or more pitches in the first game, the total number of pitches that pitcher may pitch in both games combined is the daily maximum of 95.

NOTES:

1. The withdrawal of an ineligible pitcher after that pitcher is announced, or after a warm-up pitch is delivered, but before that player has pitched a ball to a batter, shall not be considered a violation. Little League officials are urged to take precautions to prevent protests. When a protest situation is imminent, the potential offender should be notified immediately.

A.R.—**Minor League and Little League (Majors):** When warming up, if a pitcher is discovered to be ineligible, he/she must be removed and the previous pitcher of record may not return.

INSTRUCTOR COMMENTS

➔ *Before that player has pitched” means to a batter. When warming up, if a pitcher is discovered to be ineligible, he/she must be removed and the previous pitcher may not return. Once the manager/coach makes his/her intentions known to remove the original pitcher, the original pitcher may not return. If the ineligible pitcher is discovered “before a ball is pitched to a batter: remove the ineligible pitcher and a protest may not be filed, however, if the ineligible pitcher is discovered after “a ball is pitched to a batter” the ineligible pitcher is removed and the opposing team may protest, if desired. However, the protest must be made to the umpire before the umpire(s) leave the field at the end of the game.*

2. Pitches delivered in games declared “Regulation Tie Games” or “Suspended Games” shall be charged against pitcher’s eligibility.
3. In suspended games resumed on another day, the pitchers of record at the time the game was halted may continue to pitch to the extent of their eligibility for that day, provided said pitcher has observed the required days of rest. * ~~EXCEPTION: In the event that the first inning is not completed, all records including pitching records, batting records, etc. shall be disregarded.~~

Example 1: A league age 12 pitcher delivers 70 pitches in a game on Monday when the game is suspended. The game resumes on the following Thursday. The pitcher is not eligible to pitch in the resumption of the game because he/she has not observed the required days of rest.

Example 1: A league age 12 pitcher delivers 70 pitches in a game on Monday when the game is suspended. The game resumes on Saturday. The pitcher is eligible to pitch up to 85 more pitches in the resumption of the game because he/she has observed the required days of rest.

Example 1: A league age 12 pitcher delivers 70 pitches in a game on Monday when the game is suspended. The game resumes two weeks later. The pitcher is eligible to pitch up to 85 more pitches in the resumption of the game, provided he/she is eligible based on his/her pitching record during the previous four days.

INSTRUCTOR COMMENTS

Umpires and scorekeepers must be aware of eligible and ineligible pitcher. Do not wait until the opposing manager complains

- ➔ *A good rule of thumb for all umpires is to inquire during the pre-game conference with the managers, by asking, “Who is ineligible to pitch?” and then recording this information on the lineup card.*
- ➔ *Don’t hold the game up because one team challenges the eligibility by trying to track down the official scorebooks or a board member. Note the challenge in the scorebook and get on with the game.*

REGULATION VI - PITCHERS (MINOR & MAJOR SOFTBALL)

- (a) Any player on the team roster may pitch. EXCEPTION: A player who has attained a league age of twelve (12) is not eligible to pitch in the Minor League. **[CHALLENGER: Although use of the batting tee or coach pitch is strongly recommended, any player on the roster may pitch.]**
- (b) **Minors/Little League (Majors):** A player may pitch in a maximum of twelve (12) innings in a day. If a player pitches in seven (7) or more innings in a day, one calendar day of rest is mandatory. Delivery of a single pitch constitutes having pitched in an inning.

LITTLE LEAGUE (MAJORS) AND MINOR LEAGUE EXAMPLE

If a player pitched in seven (7) or more innings on (Column A), that player can pitch again on (Column B):

Column A	Column B
Sunday	Tuesday
Monday	Wednesday
Tuesday	Thursday
Wednesday	Friday
Thursday	Saturday
Friday	Sunday
Saturday	Monday

Junior/Senior League: No pitching restrictions apply.

NOTE: The local league Board of Directors or District may impose additional pitching limitations during the Regular Season and interleague.

Pitching Restrictions for 12 year olds participating in Majors and Junior League

For a 12-year-old participating in the Major and Junior League Divisions as permitted under Regulation IV(a), the pitching rules and regulations regarding days of rest that are pertinent to the division in which the pitcher is used will apply to that game. Innings pitched previously in both divisions are taken into account when determining the eligibility of the pitcher for a particular game, with respect to days of rest and number of innings available.

Example 1 – A player pitches seven innings in a Junior Division game on Sunday. On Monday, the player has a scheduled game in the Major Division. The player would not be eligible to pitch in that game because the Major Division regulations require him/ her to have one calendar day of rest, as a result of pitching in more than six innings on the previous day.

Example 2 – A player pitches nine innings in a Major Division game on Sunday. On Monday, the player has a scheduled game in the Junior Division, and he/she would be eligible to pitch in that game because the Junior Division has no pitching restrictions.

Example 3 – A player pitches in seven innings in a Junior Division game played on Sunday and has a Major Division game later that same day. The player would be limited to five more innings for the Major Division game (for a total of 12 innings in a day in the Major Division).

INSTRUCTOR COMMENTS

- This is not technically the umpire's responsibility to try and know when and how much a pitcher had pitched in a calendar week (Sunday through Saturday) but the umpire must know the rule if a question arises. The easiest way to understand this rule is ask in what division did she pitch on what day; how many innings did she pitch and what division is she pitching today. In the Major Division if she pitches in more than one inning she has to have a day of rest before she can pitch in consecutive Major Division games. In the Junior Division if she pitches less than five innings, she can pitch on consecutive days in the Junior Division but if she pitches in five or more than she has to have a day of rest before she can pitch again in the Junior Division. So if she pitched in a Major Division game for less than five innings she would be eligible to pitch the next day in a Junior Division game but if she pitched in a Junior Division game for more than one inning she would not be eligible to pitch in a Major Division game on the next day.

- (c) **Minor/Major:** A pitcher remaining in the game, but moving to a different position, can return as a pitcher anytime in the remainder of the game but only once in the same inning as he/she was removed. A pitcher, withdrawn from the game offensively or defensively for a substitute, may not re-enter the game as a pitcher. **Exception:** See Rule 3.03(c). **Junior/Senior League:** A pitcher may be withdrawn from the game, offensively or defensively, and return as pitcher once per inning provided the return does not violate the substitution, visits per pitcher, or mandatory play rule(s).

INSTRUCTORS COMMENTS:

- You should note that a softball pitcher can move to another position (staying in the game) "once in the same inning" and return to pitch, meaning each and every inning if the manager so chooses. Significantly different than the baseball rule mentioned previously in baseball Regulation VI.

- (d) **Little League (Majors) Division/Junior/Senior League Softball:** Not more than five (5) pitchers per team shall be used in one game. **EXCEPTION:** In case of illness or injury to a fifth pitcher, an additional pitcher may be used.

[MINOR LEAGUE: There is no limit of five pitchers in a game in Minors.]

INSTRUCTORS COMMENTS:

- Injury to a fifth pitcher can also mean illness. If a team insists on using a sixth pitcher, a protest may be lodged and the local league Protest Committee will be required to meet and make a decision on the game.

- (e) Violation of any section of this regulation can result in protest of the game in which it occurs. Protest shall be made in accordance with Playing Rule 4.19.

NOTES:

1. The withdrawal of an ineligible pitcher after that pitcher is announced, or after a warm-up pitch is delivered, but before that player has pitched a ball to a batter, shall not be considered a violation. Little League officials are urged to take precautions to prevent protests. When a protest situation is imminent, the potential offender should be notified immediately.

INSTRUCTOR COMMENTS:

- "Before a ball is pitched" means to a batter. When warming up, if a pitcher is discovered to be ineligible, he/she must be removed, and the previous pitcher may not return. Once the manager/coach makes his/her intentions known by removing the original pitcher, the original pitcher may not return. If the ineligible pitcher is discovered "before a ball is pitched", remove the ineligible pitcher and a protest may not be filed.

However, if the ineligible pitcher is discovered after "a ball is pitched" remove the ineligible pitcher and the opposing team may protest, if desired.

2. Innings pitched in games declared "Regulation Tie Games" or "Suspended Games" shall be charged against pitcher's eligibility. **NOTE 1:** In suspended games resumed on a subsequent day, the pitchers of record at the time the game was halted may continue to pitch to the extent of their remaining eligibility for that day.
3. **Minors/Little League (Majors):** If doubleheaders are played, the limitation of twelve (12) innings in a calendar day would apply to each pitcher. A pitcher who pitches in the first game may pitch in the second game provided that pitcher has eligibility remaining.

INSTRUCTOR COMMENTS:

- Umpires and Scorekeepers must be aware of the eligible and ineligible pitchers. Do not wait until the opposing manager complains.
- A good rule of thumb for all umpires is to inquire during the pre-game conference with the managers, by asking, "Who is ineligible to pitch?" and then recording this information on the lineup card.
- Don't hold up the game because the eligibility is challenged by one team by trying to track down the official scorebooks or a board member. Note the challenge in the scorebook and get on with the game

4. There is no limit to the number of pitchers of a particular league age group on a team that can be used. **EXCEPTION:** A player who has attained a league age of twelve (12) is not eligible to pitch in the Minor League.

INSTRUCTOR COMMENTS:

- Nine innings in a calendar day can amount to a variety of innings configurations. A pitcher may start both games, relieve in both games, start one and finish the other, etc., as long as the nine-inning provision is followed.

XIV - FIELD DECORUM

- (a) The actions on or off the field, of players, managers, coaches, umpires, and league officials must be above reproach. Any player, manager, coach, umpire, or league representative who is involved in a verbal or physical altercation, or an incident of unsportsmanlike conduct, at the game site or any other Little League activity including through online or social media, is subject to disciplinary action by the local league Board of Directors (or by the district, if the Senior League is administered as a district operation).
- (b) Uniformed players, news photographers, managers, coaches, and umpires only shall be permitted within the confines of the playing field just prior to and during games. Batboys and/or batgirls are not permitted at any level of play. Except for the batter, base-runners, and base coaches at first and third bases, all players shall be on their benches in their dugouts or in the bullpen when the team is at bat. When the team is on defense, all reserve players shall be on their benches or in the bullpen.

(Baseball) EXCEPTION: The on-deck position is permitted in Intermediate (50-70) Division, Junior, and Senior League.

(Softball) EXCEPTION: The on-deck position is permitted in Junior and Senior League.

[CHALLENGER: "Buddies" will be allowed within the confines of the playing field prior to and during games.]

INSTRUCTOR COMMENTS:

- Dugouts are not the area for anyone other than Players, One Manager and the rostered Coach(es). No scorekeepers or anyone else is allowed.
- Players who are not in complete uniform are not allowed in the dugout unless that player is an injured player or a player that is not going to participate for the game(s) in which case the requirement for a uniform will be waived.

- (c) Two (2) adult base coaches are allowed.

INSTRUCTOR COMMENTS:

- While adult base coaches are permitted, it is acceptable to use players as the base coach. However, the offensive team must have two base coaches in the coaches' boxes, before the ball is put into play by the umpire.

- (d) A manager or coach shall not leave the bench or dugout except to confer with a player or an umpire and only after receiving permission from an umpire. (**EXCEPTION:** In Tee Ball and Minor League, managers and coaches may be on the field for instructional purposes, but shall not assist runners or touch a live ball. At least one adult manager or coach must be in the dugout at all times.)

INSTRUCTOR COMMENTS:

- The only time a Manager or Coach is permitted out of the dugout without permission is to coach in the coaching box.
- This provision includes between innings and during any other break in the action. Managers and coaches are limited to the dugout unless serving as a base coach, talking with a pitcher during a charged conference, checking on an injured player, making a lineup change or discussing a rules decision with the umpire

- (e) The possession and/or use of firearms, tobacco products, cigarettes (including e-cigarettes and vapors), controlled substances, and alcoholic beverages in any form is prohibited on the playing field, benches, or dugouts. Alcohol is prohibited at the game site.
- (f) Managers and coaches shall not warm up pitchers.

INSTRUCTOR COMMENTS:

- Refer to rule 3.09 which states again that adults are not to warm up pitchers on the field, bullpen or elsewhere. We sometimes get mixed up with "adult warming up" a pitcher with playing catch with a player as warming up a player and it is two separate actions. One is allowed, the other is not, by rule, allowed.

OFFICIAL PLAYING RULES

Rule 1.00 — OBJECTIVES OF THE GAME

1.01- Little League Baseball (Softball) in all divisions is a game between two teams of nine players each, under the direction of a manager and not more than two (2) rostered coaches, played on a regulation Little League field in accordance with these rules, under jurisdiction of one or more umpires. **Tee Ball/Minor League Instructional Division** is a game between two teams, under the direction of a manager and not more than two rostered coaches, played on a regulation Little League field in accordance with these rules, under the jurisdiction of one or more umpires. **NOTE: Competitive Minor Leagues and above may only use nine (9) players on defense. See Rules 4.16 and 4.17.**

INSTRUCTORS COMMENTS:

- In Tee Ball and Minor League Instructional Divisions of Baseball and Softball the teams may place all or part of their rosters on the defensive field at the same time. Also, the League Board of Directors is responsible to decide how many players are listed on each team's rosters for these divisions. The League Board could elect to have 8 players (or less) on each team and play them all at the same time, on the other hand they may elect to have 15 players (or more) on each team and play them at the same time on defense. After all these programs are non-competitive and should be played as fun, instructional, and educational games. It will be up to the local league Board of Directors to approve the playing of the games with more than 9 players or less than 9 players on either or both teams. Remember these are instructional programs and should be treated as such.

1.02 - The objective of each team is to win by scoring more runs than the opponent. (**Tee Ball:** It is recommended that no score be kept.)

1.03 -The winner of the game shall be that team which shall have scored, in accordance with these rules, the greater number of runs at the conclusion of a regulation game.

1.04 - THE PLAYING FIELD. The field shall be laid out according to the instructions, supplemented Diagram by No. 1 and No. 2. (Baseball/Softball) The infield shall be a 60-foot square. Diagrams No. 3, No. 4 and No. 5 for **Intermediate (50-70) Division/Junior/Senior League** (Baseball).

(**Tee Ball option:** The infield may be a 50-foot square.)

[**INTERMEDIATE (50-70) DIVISION BASEBALL: 90-foot square.**]

[**JUNIOR/SENIOR LEAGUE BASEBALL: 90-foot square.**]

[**CHALLENGER: The infield shall be a 50- or 60-foot square.**]

The outfield shall be the area between two foul lines formed by extending two sides of the square, as in Diagram 1. The distance from home base to the nearest fence, stand, or other obstruction on fair territory should be 200 feet or more

Baseball: [200 feet or more for **Intermediate (50-70) Division** and 300 feet or more for **Junior/Senior League**]. A distance of 200 feet or more [200 feet or more for **Intermediate (50-70) Division** and 300 feet or more for **Junior/Senior League**] along the foul lines and to center field is recommended. The infield shall be graded so that the base lines and home plate are level.

Softball: A distance of 200 feet or more along the foul lines, and to center field is recommended. The outfield fence must be a minimum of 180 feet and a maximum of 225 feet from home plate. The infield shall be graded so that the base lines and home plate are level.)

Pitcher's plate

Baseball: The pitcher's plate shall be six inches [eight inches for **Intermediate (50-70) Division** and 10 inches for **Junior/Senior League**] above the level of home plate.

Softball: Little League /Junior/Senior League: The pitcher's plate shall be level with the ground.

The infield and outfield, including the boundary lines, are fair territory and all other area is foul territory

INSTRUCTOR COMMENTS:

- Diagrams No. 6 and No. 7 indicate the configuration of the pitcher's mound, including the proper placement of the pitcher's plate the dimensions of the table and the front and rear slopes.
- While not advisable, it is permissible for a game to be played with a mound less than six inches high in Little League Baseball and ten inches in Senior League Baseball.
- The use of a portable mound is acceptable in Regular Season games only.

It is desirable that the line from home base through the pitcher's plate to second base shall run east-northeast.

It is recommended that the distance from home base to the backstop, and from the base lines to the nearest fence, stand or other obstruction on foul territory should be 25 feet or more [45 feet or more for **Intermediate (50-70) Division/Junior/Senior**]. See Diagram 1.

When the location of home base is determined, with a steel tape measure 84 feet, 10 inches ...

Baseball: (99 feet for **Intermediate (50-70) Division** and 127 feet, 3 ¾ inches for **Junior/Senior League**) in the desired direction to establish second base. From home base, measure 60 feet (70 feet for **Intermediate (50-70) Division** and 90 feet for **Junior/Senior League**) towards first base; from second base, measure 60 feet (70 feet for **Intermediate (50-70) Division** and 90 feet for **Junior/Senior League**) towards first base, the intersection of these lines establishes first base. From home base, measure 60 feet (70 feet for **Intermediate (50-70) Division** and 90 feet for **Junior/Senior League**) towards third base; from second base, measure 60 feet (70 feet for **Intermediate (50-70) Division** and 90 feet for **Junior/Senior League**) towards third base, the intersection of these lines establishes third base. The distance between first base and third base is 84 feet, 10 inches (99 feet for **Intermediate (50-70) Division** and 127 feet, 3 ¾ inches for **Junior/Senior League**). All measurements from home base shall be taken from the point where the first and third base lines intersect. (Base paths of 80 feet are optional for **Junior League** regular season play only.)

Softball: in the desired direction to establish second base. From home base, measure 60 feet towards first base; from second base, measure 60 feet towards first base, the intersection of these lines establishes first base. From home base, measure 60 feet towards third base; from second base, measure 60 feet towards third base; the intersection of these lines establishes third base. The distance between first base and third base is 84 feet, 10 inches. All measurements from home base shall be taken from the point where the first and third base lines intersect.

The catcher's box, the batter's box, the base coaches boxes, and the three-foot runner's lane shall be laid out as shown in Diagrams 1 and 2.

INSTRUCTOR COMMENTS:

- ➔ In Major Division and below, there will be no need to layout the "next batter's box", since there is no "on-deck position" in these Divisions. The on-deck batter remains in the dugout, and no one in the dugout will handle a bat while in the dugout

The catcher's box extends approximately 6 feet 4 ¾ inches to the rear of home plate. It is determined by extending each foul line 9 feet beyond the back point of home plate.

Baseball: Intermediate (50-70) Division/Junior/Senior League: The rear line of the catcher's box is 8 feet directly back from the point of home plate. It extends forward to the rear line of the batter's box. It is 3 feet 7 inches wide.

Softball: Junior/Senior League: The catcher's box shall be 10 feet in length from the rear outside corners of the batter's boxes and shall be 8 feet, 5 inches wide.

The batter's box shall be rectangular, 6 feet by 3 feet ...

Baseball: [6 feet by 4 feet for **Intermediate (50-70) Division/Junior/Senior League**]. The inside line, if used, shall be parallel to and 4 inches [6 inches for **Intermediate (50-70) Division/Junior/Senior League**] away from the side of home plate. It shall extend forward from the center of home plate 3 feet and to the rear 3 feet.

Softball: The batter's box shall be rectangular 7 feet by 3 feet. The inside line, if used, shall be parallel to and 4 inches (6 inches for **Junior/Senior League**) away from the side of home plate. It shall extend forward from the center of home plate 4 feet and to the rear 3 feet.

INSTRUCTOR COMMENTS:

- ➔ If the foul lines, batter's box lines, or other lines are not correct, the umpire may choose a number of options: utilize the lines as placed; eliminate the lines; or re-line the field.

Baseball: The base coaches boxes shall be 4 feet by 8 feet (10 feet by 20 feet for **Intermediate (50-70) Division/Junior/Senior League**) and shall not be closer than 6 feet [10 feet for **Intermediate (50-70) Division/Junior/Senior League**] from the foul lines.

Softball: The coach's boxes shall be 4 feet by 8 feet and shall not be closer than 6 feet from the foul lines.

INSTRUCTOR COMMENTS:

- ➔ Keep the coaches boxes at least the minimum from the foul line and your problems of interference will be lessened considerably.

The foul lines and all other playing lines indicated in the diagrams by solid black lines shall be marked with chalk or other white material. Caustic lime must not be used.

The grass lines and dimensions shown on the diagrams are those used in many fields, but they are not mandatory. Each league shall determine the size and shape of the grassed and bare areas of its playing field.

1.05 - Home base shall be marked by a five-sided slab of whitened rubber. It shall be a 12-inch square with two of the corners filled in so that one edge is 17 inches long, two 8 ½ inches and two are 12 inches. It shall be set in the ground with the point at the intersection of the lines extending from home base to first base and to third base; with the 17-inch edge facing the pitcher's plate and the two 12-inch edges coinciding with the first and third base lines. The top edges of home base shall be beveled and the base shall be fixed in the ground level with the ground surface. The black beveled edge is not considered part of home plate

INSTRUCTOR COMMENTS:

- ➔ While it may be a surprise to some, home plate is entirely in fair territory. A ball hitting home plate can result in either a fair or foul ball, depending on what follows.
- ➔ The black beveled edge is not part of home plate, only to assist or protect sliding players who are advancing to home plate and should be covered by the infield dirt.

Diagram No. 3 Baseball

Diagram showing Intermediate (50-70) Division field layout. All dimensions are compulsory unless marked “optional” or “recommended.”

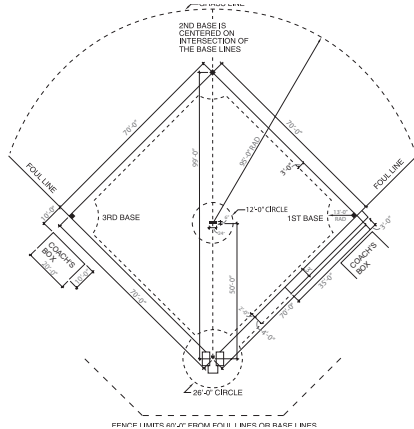
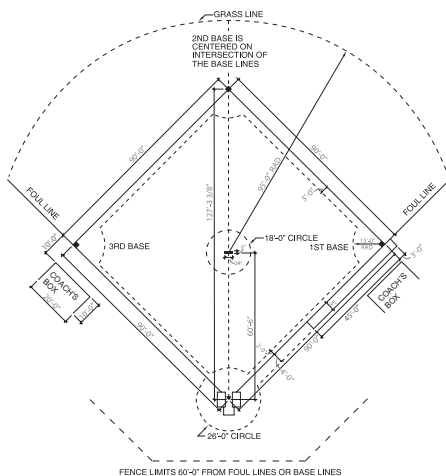

Diagram No. 4

Diagram showing Junior/Senior League field layout. All dimensions are compulsory unless marked “optional” or “recommended.”

NOTE: Junior base paths may be 80 feet.



FOOT POSITIONS RIGHT HANDED PITCHER

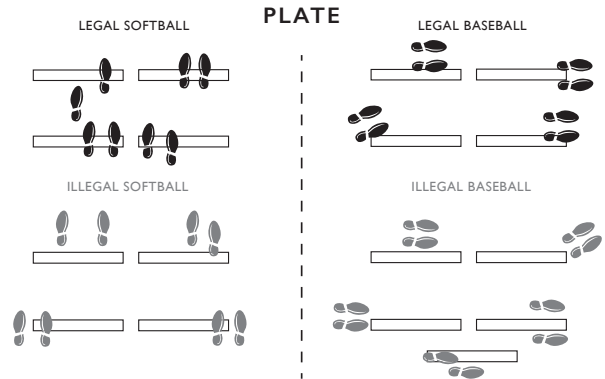
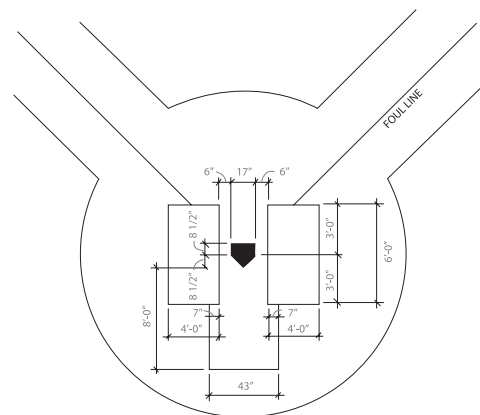

Diagram No. 5

Diagram showing layout of Intermediate (50-70) Division/ Junior/Senior League batter's box and compulsory dimensions.



1.06 - First, second and third base shall be marked by white canvas or rubber covered bags, securely attached to the ground. The first and third base bags shall be entirely within the infield. The second base bag shall be centered on second base. The base bags shall be not less than fourteen (14) nor more than fifteen (15) inches square and the outer edges shall not be more than two and one-fourth (2 1/4) inches thick, and filled with a soft material. **Leagues are required to ensure that first, second and third bases will disengage their anchor.**

NOTE 1: If a base is dislodged from its position during a play, any following runner on the same play shall be considered as touching or occupying the base if, in the umpire's judgment, that runner touches or occupies the dislodged bag or the point marked by the original location of the dislodged bag.

NOTE 2: Use of the “Double First Base” is permissible at all levels of play. See Rule 7.15.

1.07 - The pitcher's plate shall be a rectangular slab of whitened rubber...

Baseball: 18 inches by 4 inches [24 inches by 6 inches for **Intermediate (50-70) Division/Junior/Senior League**]. It shall be set in the ground as shown in the Diagrams 6 and 7, so that the distance between the front side of the pitcher's plate and home base (the rear point of home plate) shall be 46 feet [50 feet for **Intermediate (50-70) Division** and 60 feet, 6 inches for **Junior/Senior League**];

Softball: 24 inches by 6 inches. It shall be set in the ground as shown in Diagrams 1 and 2, so that the distance between the front side of the pitcher's plate and home base (the rear point of home plate) shall be — (1) **Minor League:** 35 feet; (2) **Little League (Majors):** 40 feet; and (3) **Junior/ Senior League:** 43 feet.

INSTRUCTOR COMMENTS:

→ A “step-down” version of a pitcher's plate is also acceptable. However, for purposes of the Pitching Rules (Rule 8.00), only the upper or elevated portion of this version is legally part of the plate.

Diagram No. 6 and 7

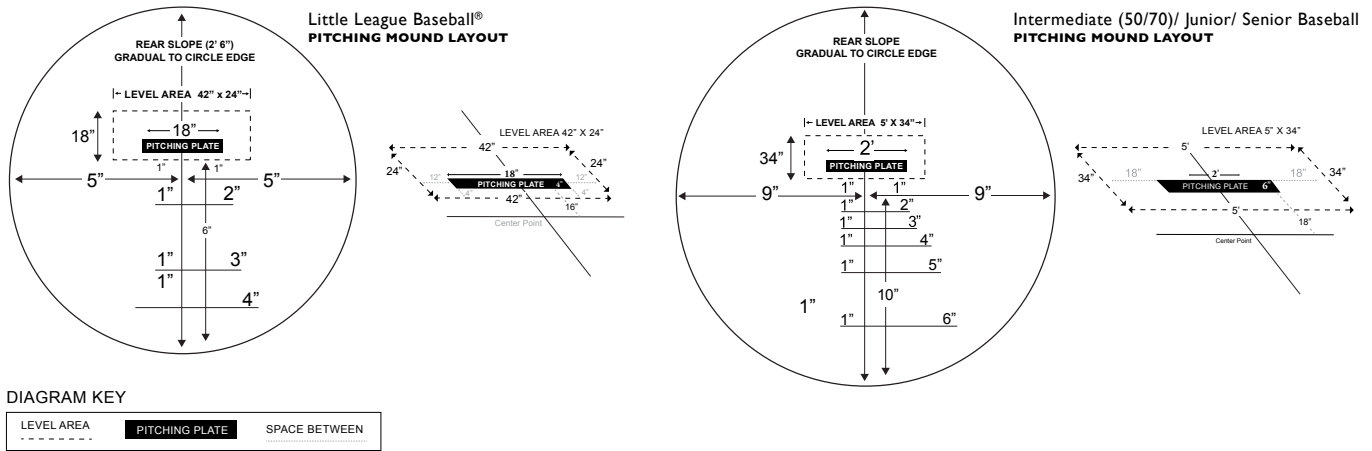

1.08 - The league shall furnish players' benches, one each for the home and visiting teams. Such benches should be not less than 25 feet from the base lines. They shall be protected by wire fencing.

NOTE 1: The on-deck position is not permitted in **Tee Ball, Minor League, or Little League (Major) Division.**

A.R.—Fenced-in areas MAY NOT be used for an on-deck batter.

NOTE 2: Only the first batter of each half-inning will be permitted outside the dugout between half-innings in **Tee Ball, Minor League, or Little League (Major) Division.**

A.R.—The next batter should be ready with a helmet on, but may not pick up a bat until it is his/her turn at bat.

INSTRUCTOR COMMENTS:

- ➔ Since there is no "on-deck position" in the Major Divisions and below, the next batter should be ready with a helmet on, but may not pick up a bat until it is his/her turn at bat. Umpires should allow the upcoming batter a few swings when he/she arrives at the plate.
- ➔ At the start of the first inning and in between innings, only one batter is permitted out of the dugout with a bat, since there is only one batter due up. All other players must remain in the dugout.

1.09 Baseball The ball used must meet Little League specifications and standards. It shall weigh not less than five (5) nor more than five and one-fourth (5 ¼) ounces, and measure not less than nine (9) nor more than nine and one-fourth (9-1/4) inches in circumference. (Tee Ball: The ball may carry the words "Little League Tee Ball.")

NOTE: Baseballs licensed by Little League will be printed with one of two designations: "RS" (for regular season play) or "RS-T" (for regular season and tournament play).

1.09 Softball - The softball used must meet Little League specifications and standards. The ball shall be not less than 11 7/8" nor more than 12 1/8" in circumference and shall weigh not less than 6¼ ounces nor more than 7 ounces. **Tee Ball/Minor League:** The ball shall be not less than 10 7/8" nor more than 11 1/8" in circumference and shall weigh not less than 5½ ounces nor more than 6 ounces.

A.R.—Optic yellow, white, or other colors of softballs are legal for use during the regular season and tournament.

INSTRUCTOR COMMENTS:

- ➔ The 12 inch ball is legal in all divisions above the Minor Division. In the Tee Ball and Minor Divisions of softball the 11 inch ball is the ball to be used.

1.10 Baseball - The bat must be a baseball bat which meets USA Baseball Bat standard (USABat) as adopted by Little League. It shall be a smooth, rounded stick, and made of wood or of material and color tested and proved acceptable to the USA Baseball Bat standard (USABat).

Beginning with the 2018 season, non-wood and laminated bats used in the Little League (Majors) and below, Intermediate (50-70) Division, and Junior League divisions shall bear the USA Baseball logo signifying that the bat meets the USABat - USA Baseball's Youth Bat Performance Standard. All BPF - 1.15 bats will be prohibited beginning with the 2018 season. Additionally, starting in 2018, the bat diameter shall not exceed 2 5/8 inches for these divisions of play. Additional information is available at LittleLeague.org/batinfo.

Tee Ball: Under the USABat standard, certified Tee Ball bats (26" and shorter) will feature the USA Baseball mark and text which reads ONLY FOR USE WITH APPROVED TEE BALLS. All Tee Ball bats must feature the USA Baseball mark and accompanying text. Tee Ball bats that were produced and/or purchased prior to the implementation of the new standard can be certified using an Approved Tee Ball Sticker via the USA Baseball Tee Ball Sticker Program (USABaseballShop.com) beginning September 1, 2017.

Little League (Majors) and below: It shall not be more than thirty-three (33) inches in length nor more than two and five eighths ($2\frac{5}{8}$) inches in diameter, and if wood, not less than fifteen-sixteenths ($\frac{15}{16}$) inches in diameter ($\frac{7}{8}$ inch for bats less than 30") at its smallest part. Wood bats taped or fitted with a sleeve may not exceed sixteen (16) inches from the small end. **NOTE:** Solid one-piece wood barrel bats do not require a USA Baseball logo.

Intermediate (50-70) Division/Junior League: it shall not be more than 34 inches in length; nor more than 2-5/8 inches in diameter, and if wood, not less than fifteen sixteenths ($\frac{15}{16}$) inches in diameter ($\frac{7}{8}$ inch for bats less than 30") at its smallest part. All non-wood bats used in these divisions must bear the USA Baseball certification mark.

NOTE: Solid one-piece wood barrel bats do not require a USA Baseball logo.

Senior League: it shall not be more than 36 inches in length, nor more than $2\frac{5}{8}$ inches in diameter, and if wood, not less than fifteen-sixteenths ($\frac{15}{16}$) inches in diameter ($\frac{7}{8}$ inch for bats less than 30") at its smallest part. The bat shall not weigh, numerically, more than three ounces less than the length of the bat (e.g., a 33-inch-long bat cannot weigh less than 30 ounces). All bats not made of a single piece of wood shall meet the Batted Ball Coefficient of Restitution (BBCOR) performance standard, and such bats shall be so labeled with a silkscreen or other permanent certification mark. The certification mark shall be rectangular, a minimum of a half-inch on each side and located on the barrel of the bat in any contrasting color. Aluminum and composite bats shall be marked as to their material makeup being aluminum or composite. This marking shall be silkscreen or other permanent certification mark, a minimum of one-half- inch on each side and located on the barrel of the bat in any contrasting color.

In all divisions, wood bats may be taped or fitted with a sleeve for a distance not exceeding sixteen (16) inches (18 inches for Intermediate (50-70) Division/Junior/Senior League) from the small end. A non-wood bat must have a grip of cork, tape, or composition material, and must extend a minimum of 10 inches from the small end. Slippery tape or similar material is prohibited.

NOTE 1: The traditional batting donut is not permissible.

NOTE 2: The use of pine tar or any other similar adhesive substance is prohibited at all levels of Little League Baseball. Use of these substances will result in the bat being declared illegal and removed from the game.

NOTE 3: Non-wood bats may develop dents from time to time. Bats that have cracks or sharp edges, or that cannot pass through the approved Little League bat ring for the appropriate division must be removed from play. The $\frac{2}{4}$ -inch bat ring must be used for bats labeled $\frac{2}{4}$. The $\frac{2}{8}$ -inch bat ring must be used for bats labeled for $\frac{2}{8}$.

Note 4: An illegal bat must be removed. Any bat that has been altered shall be removed from play. **Penalty** - See Rule 6.06(d)

A.R.—If the certification mark/s on a bat are not legible, that bat cannot be used and shall be removed from the game.

EXAMPLE 1: Any bat that does meet the specifications, an illegal bat, for that Division of play MUST be removed from the game no matter when it is discovered. **EXAMPLE 1:** Little League Baseball game: Ralph comes to bat with a bat marked "softball" **Ruling:** *This would be an illegal bat and must be removed from the game, at which time Ralph would be called out and for the first offense, the offensive team will lose one eligible adult base coach for the duration of the game.*

EXAMPLE 2: Ralph comes to bat, in a Little League baseball game, with a bat which is 34 inches long (always trying for that little edge). He hits a home run to deep center field; umpire notices that the bat is 34 inches long. **Ruling:** *This an illegal bat for this division. The home run is disallowed, any runners that were on base are returned to their basels at the time of the pitch, Ralph is called out, and for the first offense, the offensive team will lose one eligible adult base coach for the duration of the game.*

EXAMPLE 3: Colored bats are bats that come from factory stained a certain color (brown or black). Bats painted in the family garage or basements are not legal. All equipment should be checked during an umpire's pre-game activities, to make that it meets Little League specifications. Remove illegal bats at that time. substitute has played at least six consecutive outs and batted once.

1.10 Softball - The bat must be a softball bat which meets Little League specifications and standards as noted in this rule. It shall be a smooth, rounded stick and made of wood or a material tested and proved acceptable to Little League standards. The bat shall be no more than 33 inches (34 inches for **Junior/Senior League**) in length, not more than two and one-quarter ($2\frac{1}{4}$) inches in diameter, and if wood, not less than fifteen-sixteenth ($\frac{15}{16}$) inches in diameter ($\frac{7}{8}$ inch for bats less than 30 inches) at its smallest part. Non-wood bats shall be printed with a BPF (bat performance factor) of 1.20. Bats may be taped or fitted with a sleeve for a distance not exceeding 16 inches from the small end. Colored bats are acceptable. A non-wood bat must have a grip of cork, tape, or composition material, and must extend a minimum of 10 inches from the small end. Slippery tape or similar material is prohibited. **An illegal or altered bat must be removed. PENALTY** – See Rule 6.06(d).

A.R.—If the specification mark(s) on a bat are not legible, that bat cannot be used and shall be removed from the game.

NOTE 1: The traditional batting donut is not permissible.

NOTE 2: The use of pine tar or any other similar adhesive substance is prohibited at all levels of Little League Softball. Use of these substances will result in the bat being declared illegal and removed from the game.

NOTE 3: Non-wood bats may develop dents from time to time. Bats that have cracks or sharp edges, or cannot pass through the approved Little League bat ring must be removed from play. The $\frac{2}{4}$ inch bat ring must be used for bats in all softball divisions. Any bat that has been altered shall be removed from play.

INSTRUCTOR COMMENTS:

- Instead of running your hands over the bat to check for dents, etc., use the bat ring provided to your league or received in with your Umpire Registry membership materials. If the bat does not pass through the Little League Baseball approved bat ring it is out of round and should not be used. Remove it and do not allow it in the game.
- Non-wood softball bats must have the BPF of 1.20 printed legibly on the bat to be legal to be used in a game.
- Remember only a baseball bat may be used in a baseball game and only a softball bat may be used in a softball game.
- Painted bats are not acceptable, unless the painting has occurred by the manufacturer.
- At times, the sleeve of a non-wood bat is torn or is non-existent. The umpire must remove the bat for the safety of all. It is mandatory that non- wood bats be taped or fitted with a sleeve.
- Nowhere within this rule does it indicate that hands are part of the bat. Hands are not part of the bat. See Rules 6.05(f) and 6.08(b) for additional verification.
- While the traditional batting donut is not permitted, the sleeves that do not slide over the large end of the bat are acceptable.
- When removing an illegal bat or any other piece of equipment that does not meet specifications whether before or during a game, it is the manager's responsibility to see that it is removed from the dugout area, so you should ask the manager to remove it, so that it cannot be inadvertently used in the game.
- Pregame inspection of the equipment by the umpires needs to be done before each and every game to make sure that all the equipment within the dugout area is safe and meets all the Little League specifications.
- Umpires **MUST** do these inspections and the umpires should go as a team to inspect the equipment so that they are in total agreement that all the equipment meets the specifications and is safe to use in the game.
- If the certification mark/s on a bat are not legible, that bat cannot be used and should be removed from the dugout.

1.11 -

- (a) (1) All players on a team shall wear numbered uniforms identical in color, trim and style. (ALL DIVISIONS OF SOFTBALL): The wearing of hats or visors is optional for each player while on defense.
- (2) The Little League Official Shoulder Patch must be affixed to the upper left sleeve or left chest of the uniform shirt. Patches shall be placed centered on the left shoulder sleeve; or, centered on the left chest for sleeveless style. The patch may not be screen-printed or sublimated



Worn centered on the left shoulder sleeve;



Patches centered over left chest on sleeveless style.

- (3) Any part of the pitcher's undershirt or T-shirt exposed to view shall be of a solid color. A pitcher shall not wear any items on his/her hands, wrists, or arms which may be distracting to the batter.

NOTE Baseball : A pitcher shall not wear any items on his/her hands, wrists, or arms which may be distracting to the batter, e.g. sweat bands.

INSTRUCTOR COMMENTS:

- In Softball, teams may wear uniform shorts, but in order to be uniform, each player must wear shorts.
- In Softball, teams may wear hats, visors or they may choose to not wear any hats or visors. The wearing of hats or visors is optional for each player while on defense.

- (b) A league must provide each team with a distinctive uniform. Uniforms are the property of the league. **Tee Ball/Minor League:** T-shirts and caps/visors are recommended, but hand-me-down uniforms may be worn.
- (c) Sleeve lengths may vary for individual players, but the sleeves of each individual shall be approximately the same length. No player shall wear ragged, frayed, or slit sleeves.
- (d) No players shall attach to a uniform tape or other material of a different color than the uniform.
- (e) No part of the uniform shall include a pattern that imitates or suggests the shape of a (baseball or softball).
- (f) Glass buttons and polished metal shall not be used on a uniform.
- (g) No player shall attach anything to the heel or toe of the shoe other than a toe plate.

INSTRUCTOR COMMENTS:

- The toe plate may be plastic, leather or other material acceptable to the umpire.

- (h) Shoes with metal spikes or cleats are not permitted. Shoes with molded cleats are permissible. [**Baseball:** Intermediate (50-70) Division/Junior/Senior League: shoes with metal spikes or cleats are permitted. **Softball: Junior/Senior League:** Shoes with metal spikes or cleats are permitted.]

A.R.— Tee Ball/Minors/Majors: Removable spikes or cleats are permitted if, when removed, no metal remains exposed.

INSTRUCTOR COMMENTS:

- Frequently, shoes with removable spikes or cleats are used. These would be acceptable if, when removed, no metal remains exposed. If so, the shoes must be replaced.
- The molded cleats may be made of many substances other than rubber. Insure that the shoes are safe to all participants.
- Intermediate (50/70) Division/Junior/Senior League Baseball and Junior/Senior/League Softball allows metal spikes or cleats. No other division of Little League Baseball or Softball permits the use of metal cleats. No agreement can be made to alter or ignore this rule.

- (i) Managers and coaches must not wear conventional softball uniforms or shoes with metal spikes but may wear cap, slacks, and shirt. **Junior/Senior League:** Managers and coaches may wear conventional softball uniforms or cap, slacks, and shirt. They may not wear shoes with metal spikes.

INSTRUCTOR COMMENTS:

- In **Majors & Minors**, managers and coaches are allowed to wear jerseys and hats similar to their respective team's jersey, but may not wear uniform pants or similar.
- The wearing of shorts by managers and coaches shall be administered by the local jurisdiction, whether it is local league, district, section, division, state, region or World Series. Managers and coaches may wear the conventional uniform in the Intermediate 50-70/Junior/Senior/League Baseball/Softball levels.

- (j) Players must not wear jewelry such as, but not limited to, rings, watches, earrings, bracelets, necklaces, nor any hard cosmetic/decorative items. This rule applies regardless of the composition of such jewelry, hard cosmetic item, or hard decorative item. (**EXCEPTION:** Jewelry that alerts medical personnel to a specific condition is permissible.)

INSTRUCTOR COMMENTS:

- Players may wear Medic Alert necklaces or bracelets. If a player wears a Medic Alert necklace or bracelet and there is concern the item will get caught in a glove, uniform or by another player tape it to the wrist or chest, but do not ever cover the alert tag. Ensure that the tag is able to be seen by everyone, especially medical personnel.
- Managers, coaches, players & umpires may not wear pins in their hats.
- This rule now makes it very clear as to what is considered jewelry. If it isn't something for a medical condition, it is jewelry!.

- (k) Casts may not be worn during the game by players and umpires.

NOTE: Persons wearing casts, including managers and coaches, must remain in the dugout during the game.

INSTRUCTOR COMMENTS:

- The word "Plaster" has been removed from this rule to include other types of casts that can be just as dangerous to the game participants.
- Players, managers and coaches with casts may not coach in the coaches' box, not only out of concern for the injured player, manager or coach, but also for the safety of those around him/her.
- Umpires may not umpire while wearing a cast for the very same reason..

1.12 Baseball - The catcher must wear a catcher's mitt (not a first baseman's mitt or fielder's glove) of any shape, size, or weight consistent with protecting the hand.

INSTRUCTOR COMMENTS:

- Whether the catcher is a right-handed or left-handed catcher, a catcher's mitt must be worn.
 - A left-handed catcher may not wear a mitt designed for a right-handed catcher, unless the mitt is specifically designed to be worn on either hand

1.12 Softball - The catcher must wear a mitt of any shape, size, or weight consistent with protecting the hand. This may be a first baseman's mitt or a fielder's glove.

INSTRUCTOR COMMENTS:

- Softball: A catcher may wear any glove or mitt that will protect the hand.

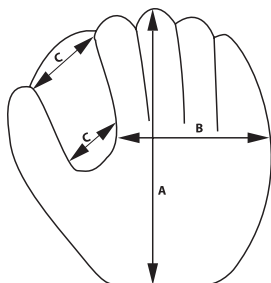

See Rule 1.13 and Rule 1.14

1.13 - The first baseman must wear a glove or mitt of any weight with the following maximum specifications:

- (a) not more than 14 inches long (measured from the bottom edge or heel straight up across the center of the palm to a line even with the highest point of the glove or mitt), and;
- (b) not more than eight inches wide across the palm (measured from the bottom edge of the webbing farthest from the thumb in a horizontal line to the outside of the little finger edge of the glove or mitt) and;
- (c) webbing not more than 5¾ inches wide (measured across the top end or along any line parallel to the top). See Diagram -No. 6 (Baseball) No. 3 (Softball)

INSTRUCTOR COMMENTS:

- In Baseball, only the first baseman may wear a first baseman's mitt.
- In Softball, the first baseman and the catcher may wear a first baseman's mitt.

1.14 - Each defensive player (other than the first baseman and catcher) must wear a glove of any weight, with the same maximum specifications as noted in Rule 1.13.

1.15 -

- (a) **(Baseball)** The pitcher's glove may not, exclusive of piping, be white or light gray nor, in the judgment of an umpire, distracting in any manner
- (a) **(Softball)** The pitcher's glove shall be of one solid color or multi-colored as long as the color(s) are not the color of the ball being used in the game. A glove that is judged to be distracting is illegal.

A.R.— Multi-colored gloves are permitted to be worn by the pitcher which includes the manufacturer's label or the lacing of the glove unless, in the umpire's judgment, these would be distracting to the batter. The umpire can remove a glove from the game if he/she determines the glove is a distraction to the batter.

INSTRUCTOR COMMENTS:

- A pitcher may not use a white or light gray glove in baseball and in Softball cannot use a white, gray or optic yellow glove. These colors cannot be included in a multi-colored glove.

- (b) **(Baseball)** No pitcher shall attach to the glove any foreign material of a color different than the glove. The pitcher may wear a batting glove on the non-pitching hand under the pitcher's glove provided the batting glove is not white, gray or optic yellow.
- (b) **(Softball)** No pitcher shall attach to the glove any foreign material of a color different from the glove.

INSTRUCTOR COMMENTS:

- Ribbons, key chains, etc. (foreign materials) may not be attached to a glove of the pitcher. By definition, foreign material is material not attached by the manufacturer.
- If the pitcher wears a batting glove he/she may not then rub the ball while still wearing the batting glove. He/she is only permitted to rub up the ball between the bare hands. See Rule 8.02(a)(b)

- (c) **(Softball)** Pitchers shall not wear any item on the pitching hand, wrist, or arm. A pitcher may wear items on the glove hand, wrist, or arm (non-pitching arm) of a solid single color: black, white, gray, or a uniform color. A pitcher shall not wear any items on his/her hands, wrists, or arms which the umpire may judge to be distracting. [See also Rule 1.11(j).] **EXCEPTION:** A pitcher may wear a compression sleeve on the pitching arm of a solid, single color: black, white, gray, or a uniform color.

INSTRUCTOR COMMENTS:

- This rule now allows the pitcher to wear a pitch/play calling device on his/her glove (non-pitching) arm.

- (d) **(Softball)** A pitcher may not wear a catcher's mitt or first baseman's mitt.

1.16 - Each league shall provide in the dugout or bench of the offensive team six (6) [seven (7) for **Intermediate (50-70) Division/Junior/Senior League**] protective helmets which must meet **NOCSAE (National Operating Committee on Standards for Athletic Equipment)** specifications and standards. Use of the helmet by the batter, all base runners, and base coaches is mandatory. Use of a helmet by an adult base coach or any defensive player is optional. Each helmet shall have an exterior warning label. Helmets must have a non-glare surface and cannot be mirror-like in nature. The helmets provided by each league must meet **NOCSAE** specifications and bear the **NOCSAE** stamp as well as an exterior warning label as noted above. **Warning!** Manufacturers have advised that altering helmets in any way can be dangerous. Altering the helmet in any form, including painting or adding decals (by anyone other than the manufacturer or authorized dealer) may void the helmet warranty. Helmets may not be re-painted and may not contain tape or re-applied decals unless approved in writing by the helmet manufacturer or authorized dealer.

A.R.—If a player, during play, removes his/her helmet or causes his/her helmet to come off, he/she shall NOT be called out, but shall be warned not to intentionally remove his/her helmet and, if it continues, the player may be removed for unsportsmanlike conduct, as this can cause an unsafe condition.

INSTRUCTOR COMMENTS:

- Painting helmets at home in the garage is extremely dangerous. Some paints will cause a chemical break down of the helmets causing them to become soft or brittle. Painting helmets can also hide cracks. Painting helmets should be done by a licensed company that will offer the league a warranty or by the manufacturer of the helmet.
- Chinstraps are not mandatory, unless they are attached to the helmet. If chinstraps are included as part of the helmet, they must be worn properly.
- Insure that players wear properly fitted helmets.
- If a player, during play, removes his/her helmet or causes his/her helmet to come off, he/she shall NOT be called out.

1.17 - All male players must wear athletic supporters. Male catchers must wear the metal, fiber or plastic type cup, and a long- model chest protector. Female catchers must wear long or short model chest protectors. [**Intermediate (50-70) Division/Junior/Senior League Baseball / Junior/Senior League Softball** catchers must wear approved long or short model chest protector] All catcher's must wear chest protectors with neck collar, throat guard, shin guards and a catcher's helmet, all of which must meet Little League specifications and standards, and bear the **NOCSAE** stamp. All catchers must wear a mask, "dangling" type throat protector and catcher's helmet during infield/outfield practice, pitcher warm-up and games. **NOTE:** Skullcaps are not permitted. Warning! Manufacturers have advised that altering helmets in any way can be dangerous. Altering the helmet in any form, including painting or adding decals (by anyone other than the manufacturer or authorized dealer) may void the helmet warranty. Helmets may not be re-painted and may not contain tape or reapplied decals unless approved in writing by the helmet manufacturer or authorized dealer

A.R.—Wearing of a catcher's helmet with mask and dangling throat guard (even if the mask has a wire extension) is required during games, pitcher warm-up, and any form of infield or infield/outfield practice. The "Hockey Style" helmet is authorized for use at all levels of play. The "dangling" throat guard still must be attached properly.

NOTE: Male players must wear athletic supporters. Male catchers must wear the metal, fiber or plastic cup type. At all levels of play, catchers must wear a catcher's helmet, not skullcap. Definition of catcher's helmet is one that covers both ears, as well as the back of the head partially down the neck. Wearing of a catcher's helmet with mask and throat guard is required during games, pitcher warm-up and any form of infield or infield/outfield practice.

INSTRUCTOR COMMENTS:

- Insure that the equipment fits properly and is worn correctly.
- During infield or outfield warm-up, the player standing next to the coach with the bat must wear the catcher's helmet, mask and throat guard.
- The warm-up catcher must wear athletic supporter (if male), catcher's helmet, mask, throat guard and catcher's mitt (baseball only). It is not necessary to wear chest protector & shin guards to warm-up the pitcher.
- The extended mask does not satisfy the throat guard requirement. The "dangling" throat guard must be an attachment to the mask (hockey style as well) that sufficiently protects the throat. The "dangling" throat guard should be attached properly so that it isn't more than a half inch to three quarters of an inch below the lowest bar of the mask and it should "dangle" or move when tapped with the finger.
- The athletic supporter requirement for male players may not be substituted by the use of brief-type underwear.
- Agreements can never be made to allow the usage of skullcaps in any division.

RULE 2.00 - DEFINITION OF TERMS

(All definitions in Rule 2.00 are listed alphabetically)

ADJUDGED is a judgment decision by an umpire.

An **APPEAL** is an act of a fielder in claiming a violation of the rules by the offensive team.

INSTRUCTOR COMMENTS:

- Not all appeals have to be made verbally, but it must be an act that is unmistakably and clearly indicated by the defensive player as an appeal to the umpire. When there are multiple runners and it is possible more than one runner could be appealed, the player must indicate to the umpire, which of the runners is being appealed. This can be accomplished by the umpire asking, "Which runner?" Whenever a defensive player is trying to make an appeal and especially if he/she seems to be confused, help the player to give you the information you need for them to make a viable appeal by asking questions, etc. This can be accomplished by asking pertinent questions without giving away, one way or the other, what your ruling will be. You are not helping them or giving an advantage to either team by doing this. If the ball is dead, just remind them that the ball is dead.

An **AT-BAT**, for the purposes of meeting the requirements of Mandatory Play (if applicable), is when a batter assumes the position of a batter with no count and is put out, called out by an umpire or reaches base. An at-bat for scorekeeping purposes is defined in the publication, "What's the Score?"

INSTRUCTOR COMMENTS:

- This rule defines an at-bat for the purpose of Regulation IV (i), mandatory play, to include a batter being called out by an umpire for the use of an illegal bat or a violation of Rule 6.07, Batting Out of Order

A **BACKSTOP** is the barrier erected behind the catcher in order to allow the catcher to retrieve passed balls easily.

A **BALK: Baseball** is an illegal act by the pitcher with a runner or runners on base entitling all runners to advance one base [Intermediate (50-70) Division/Junior/Senior League]. A balk is not called in the Little League (Major) Division and below. (See Rule 8.05 - Illegal Pitch.)

[Softball: There is no balk in softball.]

[Challenger: There shall be no balk in the Little League Challenger Division.]

A **BALL** is a pitch which does not enter the strike zone in flight and is not struck at by the batter. (**NOTE:** If the pitch touches the ground and bounces through the strike zone it is a "ball." If such a pitch touches the batter, the batter shall be awarded first base. If the batter swings at such a pitch and misses, it is a strike.) **Majors/Intermediate (50-70) Division/Junior/Senior League:** If the batter swings at such a pitch after two strikes, the ball cannot be caught for the purposes of Rule 6.05(b) and 6.09(b). If the batter hits such a pitch, the ensuing action shall be the same as if the batter hit the ball in flight.

A **BASE** is one of four points which must be touched by a runner in order to score a run; more usually applied to the canvas bags and the rubber plate which mark the base points.

A **BASE COACH** is a team member in uniform or an adult manager and/or coach who is stationed in the base coach's box at first and third base to direct the batter and the runners. **NOTE:** Two (2) adult base coaches are permitted at all levels. The second coach may be age 16 years or older. See Rule 4.05 for restrictions.

INSTRUCTOR COMMENTS:

- If a team decides to use just one adult base coach there is no requirement which coach's box an adult coach may occupy a simple rule of thumb is that the box they start the inning occupying is the box they finish the inning occupying. Do not allow the base coaches to move from 1st to 3rd and back again depending on the location of runner(s). Furthermore, an adult manager or coach is only permitted to occupy the 1st and/or 3rd base coaches box if there is at least one other adult manager or coach in the dugout (See Rule 4.05(2))

A **BASE ON BALLS** is an award of first base granted to batters who, during their time at bat, receive four pitches outside the strike zone.

NOTE: Do not grant a request for time out until the batter-runner reaches first base and forward movement has stopped and no attempt is being made to proceed to second base.

INSTRUCTOR COMMENTS:

- It is acceptable for a batter-runner to overrun first base on a base on balls. He/she cannot be tagged out when overrunning first base unless he/she makes an effort to advance to second base or fails to return to first immediately.

Challenger: BASE RUNNER - Base runners must stay in contact with the base until the ball is hit. When players have advanced as far as possible without being put out or having been retired, the umpire shall call "time" in preparation for the next batter

A **BATTER** is an offensive player who takes a position in the batter's box.

BATTER-RUNNER is a term that identifies the offensive player who has just finished a time at bat until that player is put out or until the play on which that player becomes a runner ends.

The **BATTER'S BOX** is the area within which the batter must stand during a time at bat.

The **BATTERY** is the pitcher and catcher.

The **BATTING ORDER** is the list of current defensive players (and the designated hitter in **Senior League**) in the order in which they are to bat. Exceptions: In all divisions, the batting order may contain the entire roster of players. In **Tee Ball and Minor League**, the batting order shall contain the entire roster of players.

Challenger: BATTING ORDER shall be the players listed in the order they are to bat. The batting order shall contain the entire roster of players.

Challenger: BATTING OUT OF ORDER - The scorekeeper shall inform the manager that a player has batted out of order. There shall be no penalty and that player shall not have another turn at bat, but shall resume the normal position next time up.

BENCH OR DUGOUT is the seating facilities reserved for players, substitutes, one manager and not more than two coaches when they are not actively engaged on the playing field. Bat boys and/or batgirls are not permitted.

A.R. Bench or dugout is not for additional coaches or a scorekeeper.

Challenger: A **BUDDY** is a coach or Little League player permitted on the field to assist a disabled Little Leaguer with playing skills.

Baseball: A **BUNT** is a batted ball not swung at, but intentionally met with the bat and tapped slowly. The mere holding of the bat in the strike zone is not an attempted bunt. (**Tee Ball:** Bunts are not permitted. Batters are not permitted to take a half-swing. If the umpire feels the batter is taking a half-swing, the batter may be called back to swing again.)

NOTE: The key words are “intentionally met with the bat.” Comment: If no attempt is made to make contact with a ball outside the strike zone while in the bunting stance, it should be called a ball. An effort must be made to intentionally meet the ball with the bat.

INSTRUCTOR COMMENTS:

→ **Baseball Only:** When the batter squares around in a “bunt position”, there is no need for the batter to pull the bat back. If the pitched ball is out of the strike zone, it should be called a “ball”.

Softball: A **BUNT** is a batted ball not swung at but intentionally met with the bat and tapped slowly. Holding the bat in the strike zone is considered an attempted bunt. In order to take a pitch, the batter must withdraw the bat backwards away from the ball. (**Tee Ball:** Bunts are not permitted. Batters are not permitted to take a half-swing. If the umpire feels the batter is taking a half-swing, the batter may be called back to swing again.)

INSTRUCTOR COMMENTS:

→ **Softball Only:** If the batter does not make an attempt to withdraw the bat, backwards, away from the ball and the strike zone, the umpire shall call a strike no matter where the ball is pitched.

Challenger: A **BUNT** is not permitted. Batters are not permitted to take a half swing. If the umpire feels the batter is not taking a full swing, they may be called back to swing again.

A **CALLED GAME** is one in which, for any reason, the umpire-in-chief terminates play.

A **CATCH** is the act of a fielder in getting secure possession in the hand or glove of a ball in flight and firmly holding it before it touches the ground providing such fielder does not use cap, protector, pocket, or any other part of the uniform in getting possession. It is not a catch, however, if simultaneously or immediately following contact with the ball, the fielder collides with a player, or with a wall, or if that fielder falls down, and as a result of such collision or falling, drops the ball. It is not a catch if a fielder touches a flyball which then hits a member of the offensive team or an umpire and then is caught by another defensive player. If the fielder has made the catch and drops the ball while in the act of making a throw following the catch, the ball shall be adjudged to have been caught. In establishing the validity of the catch, the fielder shall hold the ball long enough to prove complete control of the ball and that release of the ball is voluntary and intentional. A catch is legal if the ball is finally held by any fielder, even though juggled, or held by another fielder before it touches the ground. Runners may leave their bases the instant the first fielder touches the ball.

EXAMPLE 1: A legal catch occurs when a fielder holds the ball: (a) in his/her hands; (b) under his/her arm; (c) in his/her cap; (d) in his/her glove.

Ruling: (a) Yes; (b) No; (c) No; (d) Yes.

EXAMPLE 2: Batter hits a fly to center field. The center fielder gets the ball in his/her hand(s) but drops it: (a) when he/she falls to the ground and rolls over; (b) when he/she collides with a fielder or a wall; (c) when he/she starts to throw to the infield.

Ruling: In (a) and (b), it is not a catch. In (c), it is a legal catch if the ball was held long enough for the center fielder to regain his/her balance but is then dropped in a motion associated with an intended throw. Thus providing the fielder has complete control of the ball and that release of the ball is voluntary and intentional.

INSTRUCTOR COMMENTS:

- When the rule states that the player may not use “any part of the uniform” in gaining possession, it means to gain possession by utilizing a part of the uniform. Trapping the fly ball against the uniform or chest protector is okay if the player gains and maintains possession in the hand or glove or both
- Runners may advance the instant the fly ball is touched by a defensive player.
- For safety and the fact that it is a “Dead Ball Area”, a fielder may not enter the dugout to make a catch.

The **CATCHER** is the fielder who takes position back of the home base.

The **CATCHER’S BOX** is that area within which the catcher shall stand until the pitcher delivers the ball. (See Rule 4.03)

A **COACH** is an adult appointed to perform such duties as the manager shall designate. **NOTE:** if two (2) coaches are appointed, the second coach may be age 16 years or older

[**Tee Ball:** Defensive coaches are permitted on the field for instructional purposes. Coaches are not permitted to touch a live ball but they may instruct players.]

[**Tee Ball:** Offensive coaches are permitted in the coaching box and at home plate for instruction but they are not permitted to assist base runners.]

Minor Baseball/Softball Option may be adopted to allow Manager and coaches on field.]

[**In all divisions of Baseball/Softball:** Two adult base coaches are permitted.]

CROW HOP (Softball) is defined as the act of a pitcher who steps, drags or hops off the front of the pitcher’s plate, replants the pivot foot, establishing a second starting point, pushes off from the newly established starting point and completes the delivery. (Illegal Pitch - see **Softball - Rule 8.05**)

A **DEAD BALL** is a ball out of play because of a legally created temporary suspension of play.

The **DEFENSE (or DEFENSIVE)** is the team, or any player of the team, in the field.

A **DOUBLE HEADER** is two regularly scheduled or rescheduled games, played by the same team(s) on the same day.

A **DOUBLE PLAY** is a play by the defense in which two offensive players are put out as a result of continuous action, providing there is no error between putouts.

- (a) A force double play is one in which both putouts are force plays.
- (b) A reverse force double play is one in which the first out is made at any base and the second out is made by tagging a runner who originally was forced, before the runner touches the base to which that runner was forced.

DROPPED BALL (Softball) is a ball which slips from the pitcher's hand after the pitcher takes a position on the pitcher's plate, or goes directly from the pitcher's hand straight to the ground during the pitcher's motion. This can be while the pitcher is just standing on the pitcher's plate; during the back swing or up to the delivery of the pitch in the windmill motion. A drop is distinguished from a pitch in that a pitch must have lift and carry past the release of the hip and a drop slips from the hand and/or goes straight and direct to the ground. **Penalty:** See Rule 8.07(a).

DUGOUT (see definition of "BENCH").

A **FAIR BALL** is a batted ball that settles on fair ground between home and first base, or between home and third base, or that is on or over fair territory when bounding to the outfield past first or third base, or that touches first, second or third base, or that first falls on fair territory on or beyond first base or third base, or that while on or over fair territory touches the person of an umpire or player, or that, while over fair territory, passes out of the playing field in flight.

NOTE: A fair fly shall be adjudged according to the relative position of the ball and the foul line, including the foul pole, and not as to whether the fielder is on fair or foul territory at the time such fielder touches the ball.

EXAMPLE: Batted Ball settles on home plate. **Ruling:** *Fair ball.*

Play 2-4: Batted ball first hits foul ground and without touching any foreign object, rolls into fair territory between first and home, or third and home, where it settles. **Ruling:** Fair ball.

FAIR TERRITORY is that part of the playing field within, and including the first base and third base lines, from home base to the bottom of the playing field fence and perpendicularly upwards. Home plate, first base and third base and all foul lines are in fair territory.

INSTRUCTOR COMMENTS:

- Umpires shall not make a verbal call on a fair ball, simply a point into fair territory.
- Note that there are no foreign objects in fair territory, only in foul territory

A **FIELDER** is any defensive player.

FIELDER'S CHOICE is the act of a fielder who handles a fair grounder and, instead of throwing it to first base to put out the batter-runner, throws to another base in an attempt to put out a preceding runner. The term is also used by scorers (a) to account for the advance of the batter-runner who takes one or more extra bases when the fielder who handles the safe hit attempts to put out a preceding runner; (b) to account for the advance of a runner (other than by stolen base or error) while a fielder is attempting to put out another runner; and (c) to account for the advance of a runner made solely because of the defensives team indifference. (Un defended steal).

A **FLY BALL** is a batted ball that goes high in the air in flight

A **FORCE PLAY** is a play in which a runner legally loses the right to occupy a base by reason of the batter becoming a runner. (**NOTE:** Confusion regarding this play is removed by remembering that frequently the "force" situation is removed during the play. **Example:** Runner on first, one out, ground ball hit sharply to first baseman, who touches the bag and the batter-runner is out. The force is removed at that moment and runner advancing to second must be tagged. If there had been a runner at second or third, and either of these runners scored before the tag-out at second, the run(s) would count. Had the first baseman thrown to second and the ball had been returned to first the play at second would have been a force-out, making two outs, and the return throw to first would have made the third out. In that case, no run would score.)

A.R.—Runners forced to advance as a result of the batter-runner being awarded first base.

INSTRUCTOR COMMENTS:

- Example: One out. Runner on first and third. Batter flies out. Two out. Runner on third tags up and scores. Runner on first tries to retouch before throw from fielder reaches first baseman, but does not get back in time and is out. Three outs. If, in umpire's judgment, the runner from third touched home before the ball was held at first base, the run counts. The out at first base is NOT a force play.
- A force play exists any time that a runner is forced off of a base due to the batter becoming a runner. Thus, a runner being tagged out running from first to second on a ground ball is a force out.

A **FORFEITED GAME** is a game declared ended by the Umpire-in-Chief in favor of the offended team by the score of 6 to 0 [7-0 for **Intermediate (50-70) Division/Junior/ Senior League Baseball/Softball**], for violation of the rules. **Tee Ball and Challenger:** There shall be no forfeits in Tee Ball.

A **FOUL BALL** is a batted ball that settles on foul territory between home and first base, or between home and third base, or that bounds past first or third base on or over foul territory, or that first falls on foul territory beyond first or third base, or that while on or over foul territory, touches the person of an umpire or player, or any object foreign to the natural ground.

NOTE 1: A foul fly shall be judged according to the relative position of the ball and the foul line, including the foul pole, and not as to whether the fielder is on foul or fair territory at the time the fielder touches the ball.

NOTE 2: In Tee Ball, the ball is foul if it travels less than 15 feet in fair territory from home plate. The ball is also foul if the batter hits the tee with the bat.

FOUL BALL CHALLENGER: Identical to conventional baseball with two exceptions:

1. the ball is foul if it travels less than 15 feet in fair territory from home p late, and
2. the ball is foul if the batter hits the tee with the bat causing the ball to fall from the tee.

INSTRUCTOR COMMENTS:

- ➔ Remember when you call “foul”, you live with that call. You cannot change a foul call after it is made.
- ➔ The above situation is correct for a ball on the ground. Once you make a call of “Foul Ball” when the ball is on the ground, it is foul forever. However, if the ball is in the air, it may still be caught for an out and the ball would remain alive and in play.
- ➔ There is nothing in this rule to suggest that the batted ball must travel higher than the batter’s head to be an out. If not a foul tip or a rebound (See Rule 2.00-Foul Tip), the ball is a foul ball and can be caught for an out.
- ➔ On a caught fly ball in foul territory, runners may legally tag up and advance.

FOUL TERRITORY is that part of the playing field outside the first and third base lines extended to the fence and perpendicularly upwards.

A **FOUL TIP** is a batted ball that goes sharp and direct from the bat to the catcher’s hands and is legally caught. It is not a foul tip unless caught and any foul tip that is caught is a strike, and the ball is in play. It is not a catch if it is a rebound, unless the ball has first touched the catcher’s glove or hand. A foul tip can only be caught by the catcher

EXAMPLE: - Foul tip can only be caught by the catcher. **Play:** Pitched ball goes sharply from the bat into the catcher’s mask and is then caught by the catcher. **Ruling:** Foul ball. To be declared a foul tip, ball must go directly to the catcher’s glove or hand; it may rebound off the mask or chest and still be a foul tip.

INSTRUCTOR COMMENTS:

- ➔ The ball is alive and in play on a foul tip. Runners may advance as well as being thrown out on a foul tip.
- ➔ A rebound would be a ball batted sharply to the catcher that does not hit the mitt first, but is finally held by the catcher. This would not be a catch, but simply a foul ball, dead ball.

A **GROUND BALL** is a batted ball that rolls or bounces close to the ground.

The **HOME TEAM** is the team which takes the field first at the start of the game. Adopted schedules will determine which team this will be.

ILLEGAL (or ILLEGALLY) is contrary to these rules.

An **ILLEGAL BAT** is a bat that has been altered or a bat that is not approved for play because it does not meet specifications with regard to length, weight, barrel diameter, labeling or performance for the division in which it is used.

INSTRUCTOR COMMENTS:

- ➔ This rule defines an illegal bat for the purpose of Rule 6.06 (d). As a result, a bat that is, for instance, cracked or damaged because of normal use, would not be considered “illegal” and could not result in the batter being called out for using it, but the bat still must be removed from play because it could present an unsafe condition.
- ➔ This is why it is prudent that umpires check the gear before a game and have any bats that do not meet specifications, in anyway, removed from the dugout. When an illegal bat is discovered at any time, it MUST be removed from the game/dugout immediately. For any illegal bats that are discovered, at any time, see Rule 6.06 (d) for the penalty

An **ILLEGAL PITCH** is (1) a pitch delivered to the batter when the pitcher does not have the pivot foot in contact with the pitcher’s plate; ...

Baseball: (2) a quick return pitch. **Intermediate (50-70) Division/Junior/Senior League:** An illegal pitch with runners on base is a balk. (See also definition of “Pitch.”)

A.R.—This would apply to rule 8.05(e) and 8.05(g). In all other instances of Rule 8.05 with no runners on base, no penalty is enforced. In such cases, the umpire shall call “Time” and the pitcher and batter will resume the count without reference to the pitch.

Softball: (2) when the pitcher delivers the pitch with a foreign substance applied to the ball. Rosin can be applied to the hand; (3) a quick return pitch; or (4) a pitch not made in accordance with the pitching rule. **PENALTY:** The pitch shall be called a ball, unless the batter reaches first base safely on a hit, an error, a base on balls, a hit batter, fielder’s choice, or otherwise, and all base runners advance at least one base safely, in which case the play stands and the illegal pitch is nullified.

Junior/Senior League: The pitch shall be called a ball and all base runners advance one base, unless the batter reaches first base safely on a hit, an error, a base on balls, a hit batter, fielder’s choice, or otherwise, and all base runners advance at least one base safely, in which case the play stands and the illegal pitch is nullified.

An **ILLEGALLY BATTED BALL** is one hit by the batter with one or both feet on the ground entirely outside the batter’s box.

EXAMPLE: - **Play 2-6:** Batter hits fair ball while the front of his/her foot is on home plate and his/her heel is on the batter’s box line. **Ruling:** Fair ball. Batter is not out. His/her foot is not entirely outside of the batter’s box.

Play 2-7: Batter hits fair or foul ball with his/her foot entirely outside the batter’s box. **Ruling:** Batter is declared out. Rule 5.09(d).

INSTRUCTOR COMMENTS:

- ➔ Stepping on home plate when batting the ball is not an out, unless, in the judgment of the plate umpire, the batter’s foot is on the ground entirely outside the batter’s box when making contact with the ball.
- ➔ The batter is out, regardless whether the ball is batted fair or foul.
- ➔ If the batter is trying to get out of the way of a very wild pitch and the ball hits his/her bat while the batter’s foot is outside the box, he/she shall not be out. The umpire should let the play run out.
- ➔ An Illegally Batted Ball is the plate umpire’s call. Resist requests to have the base umpire make the call.

INELIGIBLE PITCHER – Applies to regular season violations of Regulation VI. (See also Rule 4.19.)

INELIGIBLE PLAYER – Applies to regular season violations of regulations regarding league age, residence (as defined by Little League Baseball, Incorporated) and participation on the proper team within the Local League. (See also Rule 4.19.)

INFIELD is that portion of the field in fair territory, which includes areas normally covered by infielders. An **INFIELDER** is a fielder who occupies a position in the infield.

An **INFIELD FLY** is a fair fly ball (not including a line drive nor an attempted bunt) which can be caught by an infielder with ordinary effort, when first and second, or first, second and third bases are occupied before two are out. The pitcher, catcher and any outfielder stationed in the infield on the play shall be considered infielders for the purpose of this rule.

When it seems apparent that a batted ball will be an infield fly, the umpire shall immediately declare “Infield Fly” for the benefit of the runners. If the ball is near the baseline, the umpire shall declare “Infield Fly, if Fair.”

The ball is alive and runners may advance at the risk of the ball being caught or retouch and advance after the ball is touched, the same as on any fly ball. If the hit becomes a foul ball, it is treated the same as any foul.

NOTE (1): If a declared Infield Fly is allowed to fall untouched to the ground, and bounces foul before passing first or third base, it is a foul ball. If a declared Infield Fly falls untouched to the ground, outside the baseline, and bounces fair before passing first or third base, it is an Infield Fly.

NOTE (2): The Infield Fly Rule does not apply in **Tee Ball**.

A.R.—The infield dirt and the outfield grass do not form a boundary line for infield fly purposes.

INSTRUCTOR COMMENTS:

- ➔ In judging “ordinary effort” by an infielder, an umpire (any umpire) must evaluate the relative age group of the players, not the individual ability of the respective player. “Ordinary effort” will change from division to division.
- ➔ Whether the ball is an infield fly or not is solely the judgment of the umpire and may not be protested. However, if the umpires forget to call the Infield Fly because of absent-mindedness the situation must be corrected. The defense must not be allowed to get a double play when the Infield Fly should have been called. Make the belated call and get the situation corrected the way the rule was intended.
- ➔ Generally, the Infield Fly is first called by the plate umpire if the infielder is moving in; in cases where the ball is even with the infielder or the infielder is moving back, the base umpire can initiate the call.
- ➔ When one umpire calls “Infield Fly,” all umpires working the game call it.
- ➔ There cannot be an Infield Fly on a bunt or a line drive, regardless if the other criteria have been met.
- ➔ When an infield fly is called, runners may advance at their own risk. If on an infield fly rule, the infielder intentionally drops a fair ball, the ball remains in play despite the provisions of **Rule 6.05(k)**. The infield fly rule takes precedence.

EXAMPLE: - The infield dirt and the outfield grass do not form a boundary line for infield fly purposes. An outfielder can catch a declared infield fly. Play: Runners on first and second, one out. Batter hits a fly ball that is called for by the left fielder. The left fielder is between the shortstop and third baseman, just one step onto the grass. Ruling: Umpire should call “Infield Fly, the batter is out.”

IN FLIGHT describes a batted, thrown, or pitched ball, which has not yet touched the ground or some object other than a fielder. If the pitch touches the ground and bounces through the strike zone, without being struck at by the batter, it is a “ball”. If such a pitch touches the batter, that batter shall be awarded first base. **Majors/Intermediate (50-70) Division/Junior/Senior League:** If the batter swings at such a pitch after two strikes, the ball cannot be caught for the purpose of Rule 6.05(b). If the batter hits such a pitch, the ensuing action shall be the same as if the ball was hit in flight

EXAMPLE: - A ball must pass through the strike zone in flight to be a strike. Any pitched ball that touches the ground and bounces through the strike zone is called a ball. A pitched ball that bounces and hits the batter is a dead ball and the batter is awarded 1st base.

INSTRUCTOR COMMENTS:

- ➔ A batted fly ball that is deflected over the fence shall be ruled a home run, since, by definition, it left the playing field “in flight.”
- ➔ In the Major Division, Intermediate (50/70) Division, Junior League and Senior League, a third strike pitch that is “short-hopped” by the catcher is considered to be not caught “in flight”. In cases where the runner would be able to run to first, he/she must be retired to be out.

IN JEOPARDY is a term indicating that the ball is in play and an offensive player may be put out.

An **INNING** is that portion of a game within which the teams alternate on offense and defense and in which there are three putouts for each team. Each team’s time at bat is a half-inning. It will be held that an inning starts the moment the third out is made completing the preceding inning. (**Minor League Only – A five-run limit is to be imposed, which would complete the half inning.**)

[**Challenger:** A league has the option of imposing a limit of five (5) runs per half inning, and/or to end the half-inning when all players on the roster have batted.]

[**Tee Ball:** The offensive side is retired when three outs are made or when all players on the roster have batted one time.]

INTERFERENCE

- (a) Offensive interference is an act by a member of the team at bat which interferes with, obstructs, impedes, hinder or confuses any fielder attempting to make a play. If the umpire declares the batter, batter-runner or a runner out for interference, all other runners shall return to the last base that was, in the judgment of the umpire, legally touched at the time of the interference, unless otherwise provided by these rule.

Baseball: A.R.—Interference does not have to be intentional for it to be called.

INSTRUCTOR COMMENTS:

- When a fielder “errs” on a play, he/she could still be considered as being in the “act of fielding a ball” if he/she is able to pick up the ball within one step or stride from his/her position. If, however, he/she must move farther than that, he/she would be considered as “chasing an erred ball” and he/she would be liable for a possible obstruction call.

- (b) Defensive interference is an act by a fielder which hinders or prevents a batter from hitting a pitch.

INSTRUCTOR COMMENTS:

- This is most often committed by the catcher but could be committed by any defensive player.

- (c) Umpire’s interference occurs (1) when an umpire hinders, impedes or prevents a catcher’s throw attempting to retire a runner or (2) when a fair ball touches an umpire on fair territory before passing a fielder.

A.R.—Only the plate umpire may interfere with the catcher and only on a cleanly caught ball or a pitched ball that doesn’t cause the catcher to move from his/her position. If the catcher errs on the ball, the umpire will be considered part of the field, and no interference results.

INSTRUCTOR COMMENTS:

- Umpire’s interference can also occur when the catcher is trying to pick a runner off of a base.
 → A fair batted ball touching a base umpire should only occur during an **Intermediate (50/70) Division, Junior, or Senior League Baseball** game, since on a sixty-foot diamond, the base umpire will be behind the infielders at the time of the pitch.

- (d) Spectator interference occurs when a spectator reaches out of the stands or goes on the playing field, and touches a live ball.

INSTRUCTOR COMMENTS:

- This can only occur on or over the playing field, either fair or foul. In or over the stands, it cannot be interference.

- (e) On any offensive interference the ball is dead at the moment the interference occurs.

EXAMPLE: - A ball is not always dead on an interference, i.e. catcher’s interference, batter’s interference, plate umpire’s interference. **Play:** Bat strikes catcher’s glove during the swing, however, the batter still manages to stroke a clean single. **Ruling:** Ignore catcher’s interference because the batter reached first safely. **Note:** If any other runner(s) are on base, they too must advance safely at least one base to ignore interference.

The **LEAGUE** is a group of teams who play each other in a pre-arranged schedule under these rules for the league championship.

Softball: LEAPING is an act by the pitcher when both feet become airborne on the initial move and push from the pitcher’s plate. (Illegal Pitch, See **Softball Rule 8.05**).

LEGAL (or LEGALLY) is in accordance with these rules.

A **LINE DRIVE** is a batted ball that goes sharp and direct from the bat to a fielder without touching the ground.

A **LIVE BALL** is a ball which is in play.

The **MANAGER** is an adult appointed by the president to be responsible for the team’s actions on the field, and to represent the team in communications with the umpire and the opposing team.

- (a) The manager shall always be responsible for the team’s conduct, observance of the official rules, and deference to the umpires.
 (b) If a manager leaves the field, that manager shall designate an adult coach as a substitute, and such substitute manager shall have the duties, rights, and responsibilities of the manager. If no adult coach is available, the Umpire-in-Chief shall designate a temporary adult manager. If no adult is available, the game or team activities shall be terminated. (See Rule 4.16.)

[Tee Ball: Defensive coaches are permitted on the field for instructional purposes. Coaches are not permitted to touch a live ball but they may instruct players.]

[Tee Ball: Offensive coaches are permitted in the coaching box and at home plate for instruction but they are not permitted to assist base runners.]

[Minor Baseball & Softball: Option may be adopted to allow Manager and coaches on field.]

OBSTRUCTION is the act of a fielder who, while not in possession of the ball, impedes the progress of any runner. A fake tag is considered obstruction. (**NOTE:** Obstruction shall be called on a defensive player who blocks off a base, base line or home plate from a base runner while not in possession of the ball)

EXAMPLE: - Obstruction is the act of: (a) a defensive player or team member which hinders or prevents a batter from striking or hitting a pitched ball; (b) a fielder, while not in possession of the ball, impedes the progress of a base runner or batter-runner who is legally running bases. (c) a fielder doing a fake tag. **Play:** Batter hits a line drive into right center. Sensing a double, he/she immediately sprints toward 2nd. As he/she rounds first the 1st baseman inadvertently steps into the base path and collides with the batter-runner. The batter-runner continues to 2nd where he/she is tagged out by a perfect throw from the center fielder. **Ruling:** *Obstruction, delayed dead ball, on the first baseman. Call time and award batter-runner 2nd base.*

INSTRUCTOR COMMENTS:

- It is quite simple now for the umpires to rule on obstruction...if the defense does not have the ball and impedes the progress of any runner it shall be called obstruction. It makes no difference if the defense is fielding a thrown ball or waiting for the ball, if the defensive player does not have the ball in his/her possession it is obstruction if they impede the progress of any runner.
- "Train wrecks are still going to happen and are not to be considered as obstruction. Example: Throw from the shortstop to the first baseman in an attempt to get a batter-runner out pulls the first baseman down the line toward home plate and the first baseman and the batter-runner collide. This is a train wreck because the defensive player is doing what he/she should be doing (fielding the ball) and the batter-runner is doing what he/she should be doing (running the bases).
- Most actions related to obstruction concern who has the right-of-way. The defense has the right to the baseline on a batted ball or when he/she already has the ball in his/her possession. The offense has the right to the baseline in all other occasions, including on a thrown ball.
- A "fake tag" is a dangerous play and must not be allowed to continue. In addition to the calling of obstruction, the player and team should be warned. Further instances could result in ejection.
- There is a difference between a "decoy" and a "fake tag." A decoy results in confusing the base runner who is not watching his/her base coaches A fake tag results in the player sliding when he/she doesn't have to slide.

OFFENSE is the team, or any player of the team, at bat.

OFFICIAL RULES. The rules contained in this book.

OFFICIAL SCORER. See Rule 10.00 in the "What's the Score" publication.

An **OUT** is one of the three required retirements of an offensive team during its time at bat.

The **OUTFIELD** is that portion of the field in fair territory which is normally covered by outfielders.

An **OUTFIELDER** is a fielder who occupies a position in the outfield, which is the area of the playing field most distant from home plate.

OVER SLIDE (or OVERSLIDING) is the act of an offensive player when the slide to a base, other than when advancing from home to first, is with such momentum that the player loses contact with the base.

A **PENALTY** is the application of these rules following an illegal act.

The **PERSON** of a player or an umpire is any part of the body, clothing or equipment.

A **PITCH** is a ball delivered to the batter by the pitcher [Baseball: **Little League/Minor League Exception:** For the purpose of maintaining a pitch count, an illegal pitch shall count as one pitch; even if a pitch is not actually thrown]

A **PITCHER** is the fielder designated to deliver the pitch to the batter.

Baseball: The Pitcher's **PIVOT FOOT** is that foot which is in contact with the pitcher's plate, as the pitch is delivered.

Softball: The Pitcher's **PIVOT FOOT** is that foot which is in contact with the pitcher's plate, as opposed to the non-pivot foot with which the pitcher steps toward home plate.

INSTRUCTOR COMMENTS:

- The pivot foot for a right-handed pitcher would be his/her right foot; left-handed pitcher, left foot.

"**PLAY**" is the umpire's order to start the game or to resume action following any dead ball.

INSTRUCTOR COMMENTS:

- Failing to call "Play" can result in considerable confusion when an attempt is made to pick off a runner. The home plate umpire **MUST** make sure to put the ball back into "play" after every dead ball interruption of play.
- "Play" is not automatic simply because the pitcher brings the ball back to the mound.

Challenger: PROTEST - There shall be no protests in the Little League Challenger Division.

A **QUICK RETURN** is a pitch made with obvious intent to catch a batter off balance. It is an illegal pitch. [**Baseball:** See Penalty 8.05(e)] [**Softball:** See Rule 8.05(c)]

REGULATION GAME. See Rules 4.10 and 4.11.

INSTRUCTOR COMMENTS:

- Situation home team leads 4-2 after three innings. In the top of the fourth, the Visitors score a run but are retired with the bases loaded. At that point, a cloudburst causes the umpire to call the game. Is this a legal contest? **Ruling:** Yes, the home team wins, 4-3. Situation Home team scores four runs in the bottom of the second inning. In the top of the sixth inning, the Visiting team scores four runs on a grand slam home run. At this point, the game is called on account of rain. **Ruling:** Home team wins the game 4-0.

A **RETOUCH** is the act of a runner returning to a base as legally required.

A **RUN (or SCORE)** is the score made by an offensive player who advances from batter to runner and touches first, second, third and home bases in that order

INSTRUCTOR COMMENTS:

- If no appeal of the runner is made, a runner is considered to have touched a base if he/she moves past the base

RUNDOWN is the act of the defense in an attempt to put out a runner between bases.

A **RUNNER** is an offensive player who is advancing toward, or touching, or returning to any base.

“**SAFE**” is a declaration by the umpire that a runner is entitled to the base for which that runner was trying

INSTRUCTOR COMMENTS:

- This should not be confused with the “safe” signal (hands outstretched), which could be indicating decisions by the umpire such as, “No Interference,” “No Catch,” “No Obstruction,” or “No Tag.” This signal would not indicate that the base runner is entitled to anything other than continuing as a base runner.

Baseball: SET POSITION is one of the two legal pitching positions.

Challenger: SIDE RETIRED - When the offense has batted through the roster, or when a predetermined number of runs has been reached, or when three outs are recorded.

A **STRIKE** is a legal pitch which meets any of these conditions -

- (a) Is struck at by the batter and missed;
- (b) Is not struck at, if any part of the ball passes through any part of the strike zone;
- (c) Is fouled by the batter when there is less than two strikes;
- (d) Is bunted foul (the batter is out and ball is dead, if the batter bunts foul on the third strike);

INSTRUCTOR COMMENTS:

- Bunting foul on the third strike is an out and the ball is dead, unless the batted ball is caught in the air. If the ball is caught in the air, the ball remains alive and in play

- (e) Touches the batter’s person as the batter strikes at it (dead ball);

EXAMPLE: - If, while swinging, the ball strikes the batter, it is a dead ball, strike.

INSTRUCTOR COMMENTS:

- This further demonstrates that hands are part of the batter’s person, not part of the bat.

- (f) Touches the batter in flight in the strike zone; or

EXAMPLE: - A batter that leans across the plate is now in the strike zone. If that batter is hit with a pitch that is in the strike zone, it is called dead ball, strike.

- (g) Becomes a foul tip. (Ball is live and in play.)

NOTE: In Tee Ball, the local league will determine whether or not strikeouts will be permitted.

Challenger: STRIKE OUT - The local league will determine whether or not Strike Outs will be permitted.

The **STRIKE ZONE** is that space over home plate which is between the batter’s armpits and the top of the knees when the batter assumes a natural stance. The umpire shall determine the strike zone according to the batter’s usual stance when that batter swings at a pitch

EXAMPLE: - Strike Zone, over home plate (17”) and between the batter’s arm pits and top of his/her knees. Beware of the batter who tries to give the impression of a small strike zone by squatting. As the umpire, you must decide his/her normal position when he/she swings. Once you determine his/her normal stance, call that strike zone. **Comment:** “Think Strikes!” *Borderline pitches should be called strikes. This encourages the offensive team to become more aggressive while at bat and provides for a more exciting game. This is not unfair to one side or the other since the two teams switch sides each half inning.*

INSTRUCTOR COMMENTS:

- Remember that the strike zone always remains over home plate. It doesn’t matter where in the box the batter stands.
- Occasionally, managers will ask the umpire at the pre-game conference, “What’s your strike zone?” Resist the urge to be too sarcastic, but the correct response would be, “Exactly as it indicates in the rule book.” What you call is your business; however, the explanation should always be the legal strike zone.

SUSPENDED GAME is a called game which is to be completed at a later date.

INSTRUCTOR COMMENTS:

- Rule 4.10(d) has been modified to allow for games after the first inning has been completed, but before the game has become regulation, to be suspended games.

A **TAG** is the action of a fielder in touching a base with the body while holding the ball securely and firmly in the hand or glove; or touching a runner with the ball or with the hand or glove holding the ball, while holding the ball securely and firmly in the hand or glove

INSTRUCTOR COMMENTS:

- Tagging or touching a player could include long hair on the player or a jacket “flapping in the breeze.” See Rule 2.00-Touch.

A **THROW** is the act of propelling the ball with the hand and arm to a given objective and is to be always distinguished from the pitch.

A **TIE GAME** is a regulation game which is called when each team has the same number of runs.

“**TIME**” is the announcement by the umpire of a legal interruption of play, during which the ball is dead.

INSTRUCTOR COMMENTS:

- Managers and players may ask for “Time” to be called, but only the umpire may call or grant “Time.”
- Umpires should resist the urge to call “Time” whenever the batter wishes time to get set in the batter’s box. Seldom will a pitcher begin his/her delivery while the batter is getting ready. If he/she does, then call “Time”.
- Holding up one hand is the same as calling “Time.” Some umpires incorrectly raise one hand up as if to say “No Pitch.” There are only two time periods that we must consider: “Time” indicates that the ball is dead. Otherwise, the ball is alive and in play.

TOUCH. To touch a player or an umpire is to touch any part of the player or umpire’s body, clothing or equipment.

A **TRIPLE PLAY** is a play by the defense in which three offensive players are put out as a result of continuous action, providing there is no error between putouts.

A **WILD PITCH** is one so high, or low, or wide of the plate that it cannot be handled with ordinary effort by the catcher

WIND-UP POSITION: Baseball is one of the two legal pitching positions.

RULE 3.00 - GAME PRELIMINARIES

3.01 - Before the game begins the umpires shall -

- (a) require strict observance of all rules governing team personnel, implements of play and equipment of players;
- (b) be sure that all playing lines (heavy lines on Diagrams No. 1 and No. 2) **[Intermediate (50-70) Division/Junior/ Senior League Baseball/Softball Diagrams No. 2 and No. 4]** are marked with non-caustic lime, chalk or other white material easily distinguishable from the ground or grass;
- (c) receive from the league a supply of baseballs which meet Little League specifications and standards; The umpire shall be the sole judge of the balls to be used in the game;
- (d) be assured by the league that additional balls are immediately available for use if required;
- (e) have possession of at least two alternate balls and shall require replenishment of such supply of alternate balls as needed throughout the game. Such alternate balls shall be put in play when -
 - (1) a ball has been batted out of the playing field or into the spectator area;
 - (2) a ball has become discolored or unfit for further use;
 - (3) the pitcher requests such alternate ball.

INSTRUCTOR COMMENTS:

- A good practice is for the umpire to rotate the balls into the game constantly to insure that the balls are worn at the same rate. This lessens the chance of a "brand new" ball being used at a strategic point in the game.

3.02- No player shall intentionally discolor or damage the ball by rubbing it with soil, rosin, paraffin, licorice, sandpaper, emery paper or other foreign substance.

PENALTY: The umpire shall demand the ball and remove the offender from the pitching position. In case the umpire cannot locate the offender, and if the pitcher delivers such discolored or damaged ball to the batter, the pitcher shall be removed from the pitching position at once.

INSTRUCTOR COMMENTS:

- Umpire demands the ball and removes that player who is intentionally discoloring or damaging the ball. Key word is intentionally. Rule of thumb for Little League players is to issue a warning to offender and manager before ejection
- Just because umpires in Little League are instructed to warn for this violation does not mean that warnings should be issued for all violations of the rules.
- This includes rubbing the ball in the dirt or picking up dirt from the mound and rubbing it on the ball.
- In preparing the ball for play, the umpires should never rub dirt on the ball while on the field. If a new ball comes into play, roll it down the baseline to your partner to rub up. The ball will collect enough dust to remove the shine, thus preparing the ball for play.

3.03 - A player in the starting line-up who has been removed for a substitute may re-enter the game ***in the SAME position** , in any position in the batting order, provided:

- (a) his or her substitute has completed one time at bat and;
- (b) has played defensively for a minimum of six (6) consecutive outs.

[MINOR Programs only -- OPTION: If a league uses 15 to 20 player rosters they may reduce the elements of this rule to one time at bat and three (3) consecutive outs.]

- (c) pitchers once removed from the mound may not return as pitchers; **Intermediate (50-70) Division/Junior/Senior:** A pitcher remaining in the game, but moving to a different position, can return as a pitcher any time in the remainder of the game, but only once per game.

*** Baseball: NOTE:** A player who has met the mandatory play requirements, and is a pitcher at the time he/she is removed, may be removed for a substitute batter and re-enter the game as pitcher once, provided the pitcher was not physically replaced on the mound.

*** Baseball: EXAMPLE:** Player A is a starter and not a pitcher. Player B substitutes into the game for Player A. Both players have met mandatory play by completing one (1) at-bat and six (6) defensive outs and both occupy the same spot in the batting order. In the fifth inning, Player A becomes a pitcher and is scheduled to bat in the sixth inning, but Player B bats for Player A. Both players have met mandatory play requirements and Player A was not physically replaced on the mound as a pitcher, therefore, Player A can return to pitch in the sixth.

Softball: Minor/Major Divisions: NOTE: A pitcher, withdrawn from the game for a substitute offensively or defensively, may not re-enter the game as a pitcher. This applies to continuous batting order. **EXCEPTION:** A pitcher may re-enter the game as a pitcher, if withdrawn for a pinch-hitter or pinch-runner, and then returned to the game at the beginning of the next half-inning.

Softball: Junior/Senior Divisions: A pitcher may be withdrawn from the game, offensively or defensively, and return as pitcher once per inning provided the return does not violate either the substitution, visits per pitcher, or mandatory play rule(s).

- (d) *** Baseball/Softball:** a starter and his/her substitute must not be in the line-up at the same time, except as provided in 3.03 NOTE 3. Once mandatory play is met, a starter and substitute(s) can enter/re-enter for each other as desired, but must re-enter in the SAME position in the batting order.
- (e) Defensive substitutions must be made while the team is on defense. Offensive substitutions must be made at the time the offensive player has her/his turn at bat or is on base.

INSTRUCTOR COMMENTS:

- Umpires are responsible for not allowing a starter to re-enter the game illegally. If a situation exists where a starter has re-entered too soon and it is not discovered until play has resumed, we have a possible protest. If discovered then, the re-entering starter is removed (since he/she re-entered improperly), the substitute has already left the game (albeit improperly) and the re-entering starter cannot return again in the game (since he/she already re-entered, improperly). The manager has “burned” two players when the umpire could have stopped it.
- The substitution requirement in 3.03 (1) and (2) states that a substitute must bat once and play six (6) consecutive defensive outs before being removed. This means that anyone who substitutes (a starter or non-starter) must meet the **substitution requirements of 1 and 2**.
- There are times when a starter cannot re-enter. If the player who substitutes for a starter fails to complete the necessary requirements, the starter may not return.
- If a game is suspended and resumed later, managers must be aware that the resumption of a suspended game is considered the same game. A starting player removed (whether it's for an injury or otherwise) before the suspension may re-enter when the game is resumed. Also, if a player is not in attendance or not on the team before the suspension, the player may enter during the resumption if he/she is then in attendance.

NOTE 1: A substitute may not be removed from the game prior to completion of his/her mandatory play requirements.

NOTE 2: When two or more substitute players of the defensive team enter the game at the same time, the manager shall, immediately before they take their positions as fielders, designate to the umpire-in-chief such player's positions in the teams batting order and the umpire-in-chief shall notify the official scorer. The umpire-in-chief shall have authority to designate the substitute's places in the batting order, if this information is not immediately provided.

INSTRUCTOR COMMENTS:

- Umpires are responsible for the lineup, and should insure that players are entered into the proper position.

NOTE 3: If during a game either team is unable to place nine (9) players on the field due to illness, injury or ejection, or inability to make a legal substitution, the opposing manager shall select a player previously used in the line up to reenter the game, but only if use of all eligible players has exhausted the roster. A player ejected from the game is not eligible for re-entry.

INSTRUCTOR COMMENTS:

- If a player, other than the pitcher, is substituted for an injured player that substitute shall be allowed five warm-up throws. (See **Rule 8.03** for pitchers)

Senior League Designated Hitter Rule:

- (a) At the beginning of a game, each manager may list on the line-up card a designated hitter to bat throughout the game for a designated player in the regular line-up. A designated hitter, who has been removed for a substitute may re-enter the game once, provided such player occupies the same batting position.
- (b) Only a player not in the regular batting order may be used as a designated hitter.
- (c) In the event a manager decides to use the designated hitter as a defensive player, the player must remain in the same position in the batting order, unless otherwise replaced by a substitute. If so, the player for whom the designated hitter was batting must be removed from the game. Such player may re-enter the game once, but only in the batting order position of the former designated hitter, who must be removed.

NOTE : If during a game either team is unable to place nine (9) players on the field due to illness, injury, or ejection, the opposing manager shall select a player previously used in the line-up to re-enter the game, but only if the use of all other eligible players has exhausted the roster. A player ejected from the game is not eligible for re-entry. This provision does not apply to injury, illness, or ejection of the designated hitter or the player for whom he or she is batting, in which case the role of the designated hitter must be terminated

INSTRUCTOR COMMENTS:

- The designated hitter and the player for whom he/she is batting occupy the same position in the batting order. If the DH is entered on defense, the player who was being hit for will be removed from the game. The two players may not occupy different positions in the batting order unless, as a result of injury or illness, the team does not have nine players remaining.

Challenger: 3.03 through 3.08 do not apply.

3.04 - A player whose name is on the team's batting order may not become a substitute runner for another member of the team. “Courtesy runner” not permitted. (See Rule 7.14)

INSTRUCTOR COMMENTS:

- This rule is intended to eliminate the practice of using so-called courtesy runners. No player in the game shall be permitted to act as a courtesy runner for a teammate. No player who has been in the game and has been taken out for a substitute shall return as a courtesy runner. Any player not in the lineup, if used as a runner, shall be considered as a special pinch runner. (See Rule 7.14) Otherwise, treat it as a substitution and the previous batter must stay on the bench until the sub plays six defensive outs and bats once.

3.05 -

- (a) The pitcher named in the batting order handed to the umpire-in-chief, as provided in Rules 4.01 (a) and 4.01 (b) shall pitch to the first batter or any substitute batter until such batter or any substitute batter is put out or reaches first base, unless the pitcher sustains injury or illness, which in the judgment of the umpire-in-chief, incapacitates the pitcher from further play as pitcher.

- (b) If the pitcher is replaced, the substitute pitcher shall pitch to the batter then at bat, or any substitute batter, until such batter is put out or reaches first base, or until the offensive team is put out, unless the substitute pitcher sustains injury or illness, which in the judgment of the umpire-in-chief, incapacitates the pitcher from further play as a pitcher.

EXAMPLE: - Starting pitchers and relief (substitute) pitchers must pitch to at least one batter or retire the side. **Play:** Line-ups are given to the umpire-in-chief at home plate. Visiting team scores ten runs in the top half of the first inning. Visiting team manager, sensing an easy victory, decides to pitch his/her second best pitcher instead of his/her ace. **Ruling:** *His/her ace must pitch to at least one batter. As umpire-in-chief, do not permit the manager to make the change until the first batter is put out, reaches first base, or the side is retired.*

INSTRUCTOR COMMENTS:

- There are circumstances such as **Rule 6.06(b)**, **Softball 7.13**, and a pickoff play in **Intermediate (50-70) Division/Junior/Senior**, where an entering relief pitcher may retire the side without pitching to a batter and not be charged with a pitch towards his/her pitch count. **SOFTBALL:** The pitcher in this case would not be charged with an inning pitched but and he/she will be recorded as one of the five pitchers used in the game.
- Umpires should insure that when receiving the lineup prior to the game that two pitchers are not listed on a team's lineup. If this happens, get it corrected immediately, before it becomes a problem.

3.06 - The manager shall immediately notify the Umpire-in-Chief of any substitution and shall state to the umpire-in-chief the substitute's place in the batting order

3.07- The Umpire-in-Chief after having been notified, shall immediately announce, or cause to be announced, each substitution.

3.08-

- (a) If no announcement of a substitution is made, the substitute shall be considered to have entered the game when -
- (1) if a pitcher, the substitute takes position on the pitcher's plate and throws one warm-up pitch to the catcher;

INSTRUCTOR COMMENTS:

- This provides, of course, that the pitcher is an eligible pitcher. If not, do not allow him/her to pitch.
- This also includes if the player throws a pitch to any other player serving in the capacity of a warm-up catcher.

- (2) if a batter, the substitute takes position in the batter's box;
- (3) if a fielder, the substitute reaches the position usually occupied by the fielder being replaced and play commences;

INSTRUCTOR COMMENTS:

- This would allow for a player to warm-up the pitcher in between innings without entering the game. Please note that the pitcher is the only defensive player who has an additional restriction (warm-up pitch).

- (4) if a runner, the substitute takes the place of the runner being replaced.
- (b) Any play made by, or on, any of the above mentioned unannounced substitutes shall be legal.

INSTRUCTOR COMMENTS:

- If the umpire notices that the substitutions are not legal before they assume the position on the field, the umpire should inform the manager and prevent the substitution from taking place.
- If you, the umpire, notice a new batter coming up to the plate to hit, ask him/her if they are a substitute for someone. Be aware of what's going on. This will keep you out of ticklish situations and away from un-called for delays
- If a substitute batter enters the batter's box and is not announced, this is considered an "unannounced substitution", not batting out of turn. If announcers are used, the announcer should only announce the batter who is physically standing in the batter's box, not the player who is due up to bat.
- It is still the responsibility of the defensive manager to monitor the opposing team's batting line-up

3.09 - Players, managers and coaches of the participating teams shall not address, or mingle with spectators, nor sit in the stands during a game in which they are engaged. Managers or coaches must not warm up a pitcher at home plate or in the bullpen or elsewhere at any time. They may, however, stand by to observe a pitcher during warm-up in the bullpen

NOTE: The time-honored practice of managers or coaches hitting infield and/or outfield practice is allowable.

INSTRUCTOR COMMENTS:

- The manager or coach may pitch batting practice as well. However, the responsibility of warming up pitchers is only that of one of the players. This includes before and during games.
- Players, managers and coaches should not be allowed to carry on a conversation with anyone outside the limits of the playing field.

3.10 -

- (a) The managers of both teams shall agree on the fitness of the playing field before the game starts. In the event that the two managers cannot agree, the president or a duly delegated representative shall make the determination.
- (b) The Umpire-in-Chief shall be the sole judge as to whether and when play shall be suspended during a game because of unsuitable weather conditions or the unfit condition of the playing field; as to whether and when play shall be resumed after such suspension; and as to whether and when a game shall be terminated after such suspension. Said umpire shall not call a game until at least thirty minutes after play has been suspended. The umpire may continue suspension as long as there is any chance to resume play.

NOTE: After the game starts, the umpire-in-chief will decide when to suspend, when to resume, or when to terminate the game.

INSTRUCTOR COMMENTS:

- Prior to the game, the duly delegated representative of the president will probably be either the league's Safety Officer or, if necessary, the game umpire.
- After the umpires assume responsibility for the game, no one, including the president, the Safety Officer, or either manager, may terminate play.
- The thirty-minute wait is not necessary if, in the umpire's judgment, there is no chance to resume play.
- In determining whether to continue, it's best for the umpire to call a game too early, rather than too late. See Rule 4.10 and 4.11 for further information. If you do not feel you can complete an inning, it's best not to start it.

3.11- Double Headers

Little League (Majors) Division: A team may play one (1) doubleheader in a calendar week. No team shall play three games in a day. (Except under condition of Rule 4.12.)

Tee Ball and Minor League: No team shall be scheduled to play two games in one day. (See Rule 4.12).

Softball: Junior/Senior League A team may play three (3) games in a day.

Baseball: Intermediate (50/70)/Junior/Senior League Baseball A team may play three (3) games in a day.

INSTRUCTOR COMMENTS:

- Minors: two teams may complete a suspended game, and then play the regularly scheduled game.
- Double-headers may be played (in divisions it's allowed) between the same two teams or different teams. One team may play two games, even if the games are against two different opponents

3.12 - When the umpire suspends play, "Time" shall be called. At the umpire's call of "Play" the suspension is lifted and play resumes. Between the call of "Time" and the call of "Play" the ball is dead.

INSTRUCTOR COMMENTS:

- If there is not a good reason for "Time" to be called, umpires should not call "Time," especially if the request is made by the defense in an effort to stop runners from advancing.

3.13 - The local league will establish ground rules to be followed by all teams in the league.

A.R. Baseball and Softball —Local ground rules should pertain to particular situations or field conditions that are not specifically covered in the rulebook, but at no time should they supersede or change the rulebook.

INSTRUCTOR COMMENTS:

- Once ground rules are established, the league should put them in writing. This will alleviate most ground rule type problems.
- **Ground rules** concern the physical layout of the facility (what is in play and what is out of play) and should not be confused with the **Playing Rules**. Leagues are not allowed to change the **Playing Rules** unless options are specifically listed in these rules (**Rule 4.04, 4.10(e), Rule 6.02(c), Rule 6.05 (b) (2), Rule 6.08 (a)(2) Minor Regulation VIII**).

3.14 - Members of the offensive team shall carry all gloves and other equipment off the field and to the dugout while their team is at bat. No equipment shall be left lying on the field, either in fair or foul territory.

INSTRUCTOR COMMENTS:

- Frequently, this becomes a problem in the **Intermediate (50/70) Division, Junior League, and Senior League** level, near the on-deck position. Unnecessary equipment on the field can result in an interference call by the umpire, leading to either an award of bases or an out call, depending on the team at fault.

3.15 - No person shall be allowed on the playing field during a game except uniformed players, managers and coaches, umpires and news photographers authorized by the league. In case of intentional interference with play by any person authorized to be on the playing field, the ball is dead at the moment of the interference and no runners on base may advance. Should an overthrown ball accidentally touch an authorized person, it will not be considered interference and the ball will remain live.

INSTRUCTOR COMMENTS:

- News photographers authorized to be on the playing field should not be setting any equipment on the field. A ball in play that gets caught up in any equipment must be declared dead.

3.16 - When there is spectator interference with any thrown or batted ball, the ball shall be dead at the moment of the interference and the umpire shall impose such penalties as in the umpire's opinion will nullify the act of interference

A.R. – If spectator interference clearly prevents a fielder from catching a fly ball, the umpire shall declare the batter out.

EXAMPLE: If a player reaches into dead ball area and a spectator interferes, a **call of interference is not made**. If a spectator reaches into a live ball area and interferes, a call of interference is made.

INSTRUCTOR COMMENTS:

- There is a difference between a ball which has been thrown or batted into the stands, touching a spectator thereby being out of play even though it rebounds onto the field and a spectator going onto the field or reaching over, under or through a barrier and touching a ball in play or touching or otherwise interfering with a player. In the latter case it is clearly intentional and shall be dealt with as intentional interference as in **Rule 3.15**. Batter and runners shall be placed where in the umpire's judgment they would have been had the interference not occurred. No interference shall be allowed when a fielder reaches over a fence, railing, and rope or into a stand to catch a ball. He/she does so at his/her risk. However, should a spectator reach out on the playing field side of such fence, railing or rope, and plainly prevent the fielder from catching the ball, then the batter should be called out for the spectator's interference.

Example: Runner on third base, one out and a batter hits a fly ball deep to the outfield (fair or foul). Spectator clearly interferes with the outfielder attempting to catch the fly ball. Umpire calls the batter out for spectator interference. Ball is dead at the time of the call. Umpire decides that because of the distance the ball was hit, the runner on third base would have scored after the catch if the fielder had caught the ball which was interfered with; therefore, the runner is permitted to score. This might not be the case if such fly ball was interfered with a short distance from home plate.

- The dugout area is treated differently than the spectator's area. A player may reach into the dugout area and, if someone causes him/her to miss the ball, interference may be called.

3.17- Players and substitutes shall sit on their team's bench or in the dugout unless participating in the game or preparing to enter the game. No one except eligible players in uniform, manager and not more than two coaches shall occupy the bench or dugout. When the batters or base runners are retired, they must return to the bench or dugout at once. Batboys and/or batgirls are not permitted. The use of electronic equipment during a game is restricted. No team shall use electronic equipment, including walkie-talkies, cellular telephones, etc for any communication with on-field personnel, including those in the dugout, bullpen, or field.

Penalty: If, in the umpire's judgment, any player, manager or coach uses an electronic communications device during the game, the penalty is ejection from the game.

NOTE: A manager or coach is permitted to use a scorekeeping and/or pitch-counting application on an electronic device without penalty, provided such device is not used to receive messages of any sort.

INSTRUCTOR COMMENTS:

- In Tee Ball and non-competitive Minor Leagues, a league may elect to use the entire roster while a team is on offense or defense. Also, if less than 9 are at the game site they may play the game with less than 9 as well.
- Injured players, managers and coaches are not allowed on the playing field if they may present a possible danger to other players or themselves.
- Injured players may be permitted in the dugout. Uniform requirements of an injured player would be at the most a team uniform shirt and hat.

3.18 - The local league shall provide proper protection sufficient to preserve order and to prevent spectators from entering the field. Either team may refuse to play until the field is cleared

NOTE: Managers are not responsible for the actions of the spectators. You cannot forfeit a game because of spectator actions.

INSTRUCTOR COMMENTS:

- The responsibility for actions of the spectator's falls to the league's Board of Directors, never the manager.
- The umpire may suspend play until the actions are corrected (see **Rule 9.01(g)**), but never forfeit or threaten to forfeit a game.
- Leagues may not write a rule that shifts responsibility to anyone other than the board.

RULE 4.00 STARTING THE GAME

4.01 - The umpires shall proceed directly to home plate where they shall be met by the managers of the opposing teams, just preceding the established time to begin the game. In sequence -

- The home team manager shall give the batting order in duplicate to the umpire-in-chief;
- Next, the visiting manager shall give the batting order in duplicate to the umpire-in-chief;
- The Umpire-In-Chief shall make certain that the original and duplicate copies are the same, then provide a copy of each batting order to the opposing manager. The original copy retained by the umpire-in-chief shall be the official batting order.
- As soon as the home team's batting order is handed to the umpire-in-chief, the umpires are in charge of the playing field and from that moment have sole authority to determine when a game shall be called, halted or resumed on account of weather or the conditions of the playing field.

NOTE 1: In tee ball and non-competitive Minor Leagues, all players on the roster may be given a defensive position. Only one player may occupy the catcher's position in Tee Ball.

[TEE BALL: Batting orders need not be exchanged between managers prior to the start of the game.]

NOTE 2: Rostered players who arrive at the game site after a game begins may be inserted in the lineup, if the manager so chooses. This applies even when a suspended game is resumed at a later date.

INSTRUCTOR COMMENTS:

- ➔ At the plate meeting only the two managers and the umpires should be present to discuss the ground rules and lineups. Leave the other coaches in the dugout.
- ➔ Don't have the home team take the field until the plate meeting has concluded and the manager has returned to the dugout.
- ➔ The official lineups are the responsibility of the Plate Umpire, no one else.
- ➔ Even in situations where the managers have presented a lineup to the Scorekeeper well in advance of game time, the lineups do not become official until the umpire receives it just prior to the start of the game.
- ➔ Obvious errors in the batting order, which are noticed by the umpire-in-chief before he/she calls "Play" for the start of the game, should be called to the attention of the manager of the team in error, so the correction can be made before the game starts. Teams should not be "trapped" later by some mistake that obviously was inadvertent and which can be corrected before the game starts.
- ➔ Changes made with the umpire prior to the game are simply changes in the starting lineup, not substitutions. Thus, when a player, who is scheduled to be a starter, is injured during infield warm-up, he/she may be replaced in the starting lineup.

4.02 - The players of the home team shall take their defensive positions, the first batter of the visiting team shall take a position in the batter's box, the umpire shall call "Play" and the game shall start.

4.03 - When the ball is put in play at the start of, or during a game, all fielders other than the catcher shall be in fair territory.

- The catcher shall be stationed in the catcher's box. The catcher may leave that position at any time to catch a pitch or make a play except that when the batter is being given an intentional base on balls, the catcher must stand with both feet within the lines of the catchers box until the ball leaves the pitcher's hand.

PENALTY (MINOR/MAJOR BASEBALL): Illegal pitch - ball called on the batter (see Rule 8.05).

[INTERMEDIATE (50/70) DIVISION/JUNIOR/SENIOR LEAGUE PENALTY: Balk with a runner or runners on base – (see Rule 8.05)]

PENALTY SOFTBALL : No pitch.

INSTRUCTOR COMMENTS:

- ➔ Make sure the catcher is out of the box when you call a balk (or illegal pitch). Don't guess. If a shadow of a doubt exists, give the catcher the benefit of the doubt

- The pitcher, while in the act of delivering the ball to the batter, shall take the legal position.
- Except the pitcher and the catcher, any fielder may be stationed anywhere in fair territory.

INSTRUCTOR COMMENTS:

- ➔ When holding a runner on first base, especially in **Intermediate (50/70) Division, Juniors, Seniors League Baseball**, the first baseman will sometimes have his/her left foot entirely in foul territory. Do not allow this to occur. Both feet must be in fair territory. Penalty for having at least one foot on the ground entirely in foul territory is **not a balk**. Simply warn the player to move into fair territory and that further occurrence can result in his/her ejection from the game.

4.04 The batting order shall be followed throughout the game unless a player is substituted for another. Substitutes must take the place of the replaced player's position in the batting order except as covered in Rule 3.03. A league may adopt a policy of a continuous batting order that will include all players on the team roster present for the game batting in order. If this option is adopted, each player would be required to bat in his/her respective spot in the batting order. However, a player may be entered and/or re-entered defensively into the game anytime provided he/she meets the requirements of mandatory play. **NOTE 1:** The continuous batting order is mandatory for all Tee Ball and Minor League Divisions. **NOTE 2:** For the Tee Ball and Minor League Division (and when the continuous batting order is adopted for other divisions) when a child is injured, becomes ill or must leave the game site after the start of the game the team will skip over him/her when his/her time at bat comes up without penalty. If the injured, ill or absent player returns he/she is merely inserted into their original spot in the batting order and the game continues. Also, if a child arrives late to a game site and if the manager chooses to enter him/her in the lineup (See Rule 4.01 NOTE 2) he/she would be added to the end of the current lineup.

A.R. – For the purpose of continuous batting order, all players listed in the batting order shall be considered starters..

INSTRUCTOR COMMENTS:

1. League uses the continuous batting order and a player gets hurt while at-bat. What do we do now? Answer: The next batter in the order takes his/her place and assumes the count and the game continues. If that injured player is unable to continue in the game the next time he/she is scheduled to bat merely skip over him/her and continue the game.
 2. League is using the CBO and a player is at bat, hits the ball and is hurt while running the bases. Who takes his place on the base? It is recommended that the last out of the previous inning is the player who is substituted to run for the injured player. Or you can even use the last out of that offensive inning. What you need to watch out for is getting in a situation where the offensive team needs a run and all of a sudden they need a runner and "they" select the team's fastest runner. Make it clean and in writing so there will never be any questions.
 3. League is using the CBO at the Junior/Senior League level and wants to take its pitcher off the mound put him/her in the dugout for a rest and bring him/her back later because he/she is still in the line up. Can they do that? No, not really. While admittedly the player is still in the batting order; however, when they took the pitcher off the mound and moved him/her to the dugout they lost their chance to bring the pitcher back. The rule was written to keep the pitcher in the lineup both offensively and defensively.
- **[MINOR Baseball & Softball:** A local league may adopt a format using the complete roster as the batting order. The side may be retired if three (3) outs occur or when a team bats through their roster or when the offensive team scores five (5) runs.]

[CHALLENGER: The batting order shall be followed throughout the game.]

4.05 - The offensive team shall station two base coaches on the field during its time at bat, one near first base and one near third base. The coaches shall not leave their respective dugouts until the pitcher has completed his/her preparatory pitches to the catcher. Base coaches shall-

- (a) be eligible players in the uniform of their team; a manager and/or coach. Both base coaches may be managers or coaches.
- (b) be a manager or coach, only if there is at least one other adult manager or coach in the dugout.
- (c) remain within the base coaches boxes at all times, except as provided in Rule 7.11;

A.R.—Once an inning starts, coaches shall not alternate between the first and third base coaches boxes.

INSTRUCTOR COMMENTS:

- Base coaches must vacate any space that is needed by the defensive fielder who is attempting to make a play on a batted or thrown

- (d) talk to members of their own team only.

An offending base coach shall be removed from the base coach's box.

INSTRUCTOR COMMENTS:

- Both coaches may be a manager and/or coaches in the coaching boxes providing the requirements of having at least one adult in the dugout are met. See Rule 4.05(2).
- Once an inning starts, coaches are locked into the box they choose. In other words, don't allow that adult to continually change from first to third and back again.
- It is common practice for a coach who has a play at his/her base to leave the coach's box to signal the player to slide, advance or return to a base.
- This may be allowed if the coach does not interfere with the play in any manner.
- The rules provide that there must be base coaches. This is not an option. Do not put the ball in play until both coaches are in their respective coaches' boxes.
- In cases where there is only one adult present with a team, by rule that one adult may NOT leave the dugout to coach in the coaches' boxes.
- Interference by a coach does not have to be intentional to be called by the umpire.

4.06 - No manager, coach or player, shall at any time, whether from the bench or the playing field or elsewhere -

- (a) incite, or try to incite, by word or sign, a demonstration by spectators;

INSTRUCTOR COMMENTS:

- This includes firing up the crowd against the umpires or opposing team. The penalty is ejection from the game.

- (b) use language which will in any manner refer to or reflect upon opposing players, manager, coach, an umpire or spectators;

INSTRUCTOR COMMENTS:

- Language from anyone that reflects badly upon opposing players, manager, coach, an umpire or spectators. Penalty is ejection.
- Most teams, particularly infielders, chatter ("Hey, batter, batter") when the ball is being delivered. This is usually acceptable, and has not caused any problems in local leagues. Do not, however, allow any player, especially the catcher, to yell "Swing" at the batter when the ball is being delivered.
- Umpires should be alert to a manager or coaches' action toward players of his/her own team as well. If the behavior warrants the adult's removal, do so.

[MINOR/MAJOR BASEBALL AND SOFTBALL]

- (c) make any move calculated to cause the pitcher to commit an illegal pitch [a balk in **Baseball: Intermediate (50-70) Division/Junior/Senior League**];

INSTRUCTOR COMMENTS:

- Stop this maneuver immediately.
- This could involve many acts, such as the batter stepping out of box or raising his/her hand toward the pitcher, the base coach yelling “Go” or “Balk”, the base runner yelling, or the manager yelling “Time” from the dugout.
- The base runner clapping his/her hands or kicking the dirt is normally not a problem and should be ignored.

(d) take a position in the batter’s line of vision, with the deliberate intent to distract the batter.

The umpire may first warn the player, coach, and/or manager. If continued, remove the player, coach, and/or manager from the game or bench. If such action causes an illegal pitch [a balk in **Intermediate (50-70) Division/Junior/Senior League**], it shall be nullified.

EXAMPLE: First baseman or third baseman crowding a batter in an obvious bunt situation. Another example would be a shortstop or second baseman jumping up and down and waving their arms during the pitch.

INSTRUCTOR COMMENTS:

- The offender shall be removed from the game. As an umpire you must adjudge whether a team’s cheering is being done to distract the pitcher or fielders. If the cheering gets real loud or stops suddenly as the pitcher is trying to deliver a pitch or a fielder is trying to make a play, the umpire should warn the team that cheering in this form will not be allowed.

4.07 - When a manager, coach, or player is ejected from a game, they shall leave the field immediately and take no further part in that game. They may not sit in the stands and may not be recalled. **A manager or coach ejected from a game must not be present at the game site for the remainder of that game.** Any manager, coach, or player ejected from a game is suspended for his or her team’s next physically played game and may not be in attendance at the game site from which they were suspended. This includes pregame and postgame activities.

INSTRUCTOR COMMENTS:

- In Little League programs, if the player will not cause a disturbance for the remainder of the game, it’s acceptable, and advisable, to leave him/her in the dugout. At least he/she will be supervised there. However, the player will take no further part in the game, including serving as a base coach or warming up other players.
- A manager or coach ejected from the game will leave the area completely and immediately. Should he/she fail to do so, the game may be suspended until compliance occurs. Furthermore, managers, coaches and players that are ejected may not attend the next game the team physically plays, even as a spectator. Ensure that a report is sent to the League’s UIC and the President outlining exactly what caused the ejection.

4.08 - When the occupants of a player’s bench show violent disapproval of an umpire’s decision, the umpire shall first give warning that such disapproval shall cease. If such action continues -

PENALTY: The umpire shall order the offender out of the game and away from the spectator’s area. If the umpire is unable to detect the offender or offenders, the bench may be cleared of all players. The manager of the offending team shall have the privilege of recalling to the playing field only those players needed for substitution in the game.

INSTRUCTOR COMMENTS:

- If you cannot determine who is causing the disturbance, after warning, remove the manager. He/she is responsible for his/her team’s actions.

4.09 - HOW A TEAM SCORES

- (a) One run shall be scored each time a runner legally advances to and touches first, second, third and home base before three players are put out to end the inning.

EXCEPTION: A run is not scored if the runner advances to home base during a play in which the third out is made (1) by the batter-runner before touching first base; (2) by any runner being forced out; or (3) by a preceding runner who is declared out because that runner failed to touch one of the bases (appeal play).

A.R. One out, Jones on third, Smith on first and Brown flies out to right field for the second out. Jones tags up and scores after the catch. Smith attempted to return to first but the right fielder’s throw beat “Smith” to the base for the third out. But Jones scored before the throw to catch Smith reached first base. Hence, Jones’ run counts. It was not a force play.

EXAMPLE: - Play: One out...runners on first and second. Batter smashes a double to left field. Runner from second scores but runner from first is thrown out at the plate. The batter advances to second safely BUT is declared out on appeal for missing first base. Does the run score???

Ruling: No! The runner crossed the plate on a play in which the batter-runner made the third out before he/she touched first base.

INSTRUCTOR COMMENTS:

- Numerous situations can develop that will nullify runs. The umpire should remember the basic elements of this rule and particularly the three exceptions. Generally, any run that scores during a play in which the third out is made by one of the three exceptions will not count.

- (b) When the winning run is scored in the last half inning of a regulation game, or in the last half of an extra inning, as a result of a base on balls, hit batter or any other play with the bases full which forces the runners to advance, the umpire shall not declare the game ended until the runner forced to advance from third has touched home base and the batter-runner has touched first base

INSTRUCTOR COMMENTS:

- When the winning run is **forced in**, it is important for the umpire to be aware of each runner's legal obligation, including the batter-runner.
- (1) If the winning run is forced in as the result of a **batted ball**, all runners including the batter-runner are obligated to touch their next bases. The BR must advance to and touch 1st base, and any other runner forced must advance to and touch his/her next base. If any such forced runner fails to do so, a force out appeal play is in order; and if it is sustained for the third out, no run shall count since the third out was, in effect, a force out. If this appeal force out is not the third out, the runner shall be declared out but the winning run scores.
- (2) If the winning run is forced in as the result of an **award** (e.g. base on balls, hit batsman, catcher interference), the runner from third is required to advance to and touch home **and** the batter-runner is required to advance to and touch first base before the game is over. The other runners on base are not required to touch their next bases when the winning run is forced in as the result of an award.

4.10 -

- (a) A regulation game consists of six innings [**Baseball: Intermediate (50-70) Division/ Baseball and Softball: Junior/Senior League:** seven innings], unless extended because of a tie score, or shortened (1) because the home team needs none of its half of the sixth inning [**Baseball: Intermediate (50-70) Division/ Baseball and Softball: Junior/Senior League:** seventh] or only a fraction of it; or (2) because the umpire calls the game.
- (b) If the score is tied after six completed innings (**Baseball: Intermediate (50-70) Division/ Baseball and Softball: Junior/Senior League:** seven innings), play shall continue until (1) the visiting team has scored more total runs than the home team at the end of a completed inning; or (2) the home team scores the winning run in an uncompleted inning.
- (c) If the game is called, it is a regulation game -
- (1) If four [**Baseball: Intermediate (50-70) Division/ Baseball and Softball: Junior/Senior League:** five innings] have been completed;
 - (2) If the home team has scored more runs in three and a half innings [**Baseball: Intermediate (50-70) Division/ Baseball and Softball: Junior/Senior League:** four and a half innings] than the visiting team has scored in four completed half-innings;
 - (3) If the home team scores one or more runs in its half of the fourth [**Baseball: Intermediate (50-70) Division/ Baseball and Softball: Junior/Senior League:** fifth] inning to tie the score.
- (d) If a game is called before it has become a regulation game, it shall be resumed exactly where it left off.

NOTE: All records, including pitching, shall be counted

- (e) * If after three (3) innings [**Baseball: Intermediate (50-70) Division/ Baseball and Softball: Junior/Senior League:** four (4) innings], two and one-half innings [**Baseball: Intermediate (50-70) Division/ Baseball and Softball: Junior/Senior League:** three and one-half innings] if the home team is ahead, one team has a lead of fifteen (15) runs or more, the manager of the team with the least runs shall concede the victory to the opponent. If after four (4) innings [**Intermediate (50-70) Division/Baseball and Softball Junior/Senior League:** five innings], three and one-half innings [**Intermediate (50-70) Division/Baseball and Softball Junior/Senior League:** four and one-half innings] if the home team is ahead, one team has a lead of ten (10) runs or more, the manager of the team with the least runs shall concede the victory to the opponent.

NOTE: (1) If the visiting team has a lead of *fifteen (15) or ten (10) runs or more *respectively, the home team must bat in its half of the inning.
(2) The local league may adopt the option of not utilizing this rule.

INSTRUCTOR COMMENTS:

- This rule is not an option for either manager.
- Please remember that the game must complete enough innings to be considered a regulation game.
- The home team and visiting team are treated differently. If the visiting team scores enough runs to take a 10-run lead, the game continues until the home team has completed an equal number of innings; if the home team takes a 10-run lead, after it has become a regulation game, the game must stop immediately.

[**MINOR Baseball & Softball:** A local league may impose a time limit on Minor League games regardless of the number of innings played.]

- (f) **Tee Ball:** The local league may determine appropriate game length but shall not exceed 6 innings. It is recommended that Tee Ball games be 4 innings or 1-1/2 hour time limit.]

EXAMPLE: - Play: The home team leads 4-2 after three innings. In the top of the fourth, the Visitors score a run but are retired with the bases loaded. At that point, a cloudburst causes the umpire to call the game. Is this a legal contest? **Ruling:** *Yes, the home team wins, 4-3.*

Play: Home team scores four runs in the bottom of the second inning. In the top of the sixth inning, the Visiting team scores four runs on a grand slam home run. At this point, the game is called on account of rain. **Ruling:** *Home team wins the game 4-0. (Umpires - make this call from your cell phone as you clear the complex gate).*

4.11 - The score of a regulation game is the total number of runs scored by each team at the moment the game ends.

- (a) The game ends when the visiting team completes its half of the sixth inning [**Baseball: Intermediate (50-70) Division/ Baseball and Softball: Junior/Senior League:** seventh inning] if the home team is ahead.
- (b) The game ends when the sixth inning [**Baseball: Intermediate (50-70) Division/ Baseball and Softball: Junior/Senior League:** seventh inning] is completed, if the visiting team is ahead.
- (c) If the home team scores the winning run in its half of the sixth inning [**Baseball: Intermediate (50-70) Division/ Baseball and Softball: Junior/Senior League:** seventh inning] (or in its half of an extra inning after a tie), the game ends immediately when the winning run is scored.

NOTE: Once a game becomes regulation and it is called with the home team taking the lead in an incomplete inning, the game ends with the home team the winner.

EXCEPTION: If the last batter in a game hits a home run out of the playing field, the batter-runner and all runners on base are permitted to score, in accordance with the base-running rules, and the game ends when the batter-runner touches home plate.

A.R. - The batter hits a home run out of the playing field to win the game in the last half of the sixth [**Baseball: Intermediate (50-70) Division/ Baseball and Softball: Junior/Senior League:** seventh] or an extra inning, but is called out for passing a preceding runner. The game ends immediately when the winning run is scored.

(d) A called game ends at the moment the umpire terminates play.

EXCEPTION: If the game is called during an incomplete inning, the game ends at the end of the last previous completed inning in each of the following situations:

- (1) The visiting team scores one or more runs to tie the score in the incomplete inning, and the home team does not score in the incomplete inning.
- (2) The visiting team scores one or more runs to take the lead in the incomplete inning, and the home team does not tie the score or retake the lead in the incomplete inning.

(e) A regulation game that is tied after four [**Baseball: Intermediate (50-70) Division/ Baseball and Softball: Junior/Senior League:** five] or more completed innings and halted by the umpire, shall be resumed from the exact point that play was halted. The game shall continue in accordance with **Rule 4.10 (a) and 4.10 (b).**

NOTE: When a TIE game is halted, the pitcher of record may continue pitching in the same game on any subsequent date provided said pitcher has observed the required days of rest for his/her particular age group. For scorekeeping purposes, it shall be considered the same game, and all batting, fielding and pitching records will count.

Little League Baseball and Softball (Major/Minors) Example:

Rule 4.11		1	2	3	4	5	6
VISITORS	0	0	0	4	1		
HOME	0	0	0	5			

Game called in top of 5th inning on account of rain. Score reverts to last completed inning (4th) and the home team is the winner 5 to 4.

Intermediate (50/70) Baseball - Junior/Senior League Baseball and Softball Example:

Rule 4.11		1	2	3	4	5	6
VISITORS	0	0	0	4	1		
HOME	0	0	0	5			

Game called in top of 6th inning on account of rain. Score reverts to last completed inning (5th) and the home team is the winner 5 to 4.

INSTRUCTOR COMMENTS:

- ➔ If the game is tied at the end of a completed inning, and the home team does not take the lead in an incomplete inning; the game is suspended, since you cannot revert to a tie game.
- ➔ If the home team is ahead at the end of a completed inning, and the visiting team takes the lead and the home team does not tie or go ahead in an incomplete inning, the game reverts to the previous inning, home team wins.
- ➔ Thus, the home team is the only team that can benefit by reverting to a previous inning.
- ➔ As mentioned in **Rule 3.10**, the umpire should be careful not to start an inning unless he/she feels that he/she has a reasonable expectation to complete the entire inning.

4.12 - Tied games halted due to weather, curfew or light failure shall be resumed from the exact point at which they were halted in the original game. It can be completed preceding the next scheduled game between the same teams.

Baseball: A player may not pitch in more than one game in a day. (**Exception: Junior and Senior League:** If the player pitched 30 or fewer pitches in the first game, that player may pitch in the second game on that day.)

Softball: A pitcher can pitch in both games on same day subject to Regulation VI(b).

Baseball/Softball: The lineup and batting order of both teams shall be the same as the lineup and batting order at the moment the game was halted, subject to the rules governing substitution. Any player may be replaced by a player who was not in the game prior to halting the original game.

No player once removed before the game was halted may be returned to the lineup unless covered by Rule 3.03.

NOTE: When a Tie game is halted, the pitcher of record may continue pitching in the same game on any subsequent date provided said pitcher has observed the required days of rest for his/her particular age group. For scorekeeping purposes, it shall be considered the same game, and all batting, fielding and pitching records will count.

Little League (Majors/Minors) Baseball and Softball Examples:

Rule 4.12

	1	2	3	4	5	6
VISITORS	0	0	0	0	4	5
HOME	0	0	0	0	4	

Tie games halted due to weather, curfew, or light failure shall be resumed from the exact point at which they were halted in the original game.

Game called in the top of the 6th inning, visiting team batting with two out, no base runners - this is a tie game. Resume the game in the top of the 6th, visiting team at bat, two out.

Intermediate (50/70) Division (Baseball) Junior/Senior League Baseball and Softball Example:

Rule 4.12

	1	2	3	4	5	6	7
VISITORS	0	0	0	0	0	4	5
HOME	0	0	0	0	0	4	

Tie games halted due to weather, curfew, or light failure shall be resumed from the exact point at which they were halted in the original game.

Game called in top of 7th inning, visiting team batting with two out, no base runners this is a tie game. Resume the game in the top of the 7th, visiting team at bat, two out.

EXAMPLE: 5-5 tie after seven complete innings, game halted because of darkness. Little Bobby missed the full seven innings because of family obligations. Game is resumed two weeks later and little Bobby is present for the resumption. Can he/she play?

Ruling: *An eligible player is any player in uniform whose name appears on the team roster. Yes, he/she may play*

INSTRUCTOR COMMENTS:

→ Baseball: The pitcher of record may continue subject to the pitch count limitations provided in Regulation VI and provided for his/her particular age group.

4.13 - Double Headers

Baseball: Little League (Majors): A team may play one (1) doubleheader in a calendar week. No team shall play three games in a day. (Exception under condition of Rule 4.12.)

Softball: Minors/Little League (Majors): A team may play two (2) doubleheaders in a seven-day period. No team shall play three games in a day. (Exception under condition of Rule 4.12.)

Minor League (Baseball) and Tee Ball: No team shall be scheduled to play two games in one day. (See Rule 4.12.)

Baseball: Intermediate (50-70) Division/ Junior/Senior League: Doubleheaders are permitted.

Softball: Junior/Senior League: A team may play three (3) games in a day.

4.14 - The Umpire-in-Chief shall order the playing field lights turned on whenever in such umpire's opinion that darkness makes further play in daylight hazardous.

INSTRUCTOR COMMENTS:

→ Try to turn lights on at the top of an inning. However, if darkness makes further play hazardous "turn the lights on!" Don't wait until the home team finishes its turn at bat.

4.15 - A game may be forfeited by the umpire-in-chief of the game in progress to the opposing team when a team -

- (a) being upon the field, refuses to start play within 10 minutes after the appointed hour for beginning the game, unless such delay, in the umpire's judgment is unavoidable;

EXAMPLE: Star pitcher is late; manager wants to wait 20 minutes for him/her. Not an acceptable reason.

- (b) refuses to continue play unless game was terminated by the umpire;

EXAMPLE: Manager upset by umpires' calls or because he/she didn't wear his/her lucky shirt and refuses to continue.

- (c) fails to resume play, after game was halted by the umpire, within one minute after the umpire has called "Play";

EXAMPLE: Rain delay, umpire says "play" but manager disagrees

- (d) fails to obey within a reasonable time the umpire's order to remove a player from the game;

Ruling: One minute is a reasonable time.

- (e) after warning by the umpire, willfully and persistently violates any rules of the game;

EXAMPLE: Encouraging base-runners to leave base early, violating substitution rule by using a courtesy runner, etc.

- (f) employs tactics designed to delay or shorten the game.

EXAMPLE: Having his/her players confer on the pitcher's mound in the third inning as the sun sets in the west, and many more too numerous to list. Rule of Thumb: Do everything humanly possible to prevent a forfeit. Do not take the game away from the children, if possible

[CHALLENGER: Forfeits are not to be declared. Every effort must be made to play all games to ensure compliance with the philosophy of the Little League Challenger Division. Tee Ball: Forfeits are not to be declared.]

INSTRUCTOR COMMENTS:

→ Please remember that the umpire-in-chief records a forfeit. However, all forfeits are subject to review by the Board of Directors. See Rule 4.19 (f)

4.16 -If a game cannot be played because of the inability of either team to:

- (a) Place nine players on the field before the game begins, and/or
- (b) Place at least one adult in the dugout as manager or acting manager, this shall not be grounds for automatic forfeiture, but shall be referred to the Board of Directors for a decision.

NOTE: A game may not be started with less than nine (9) players on each team, nor without at least one adult as manager or substitute manager.

INSTRUCTOR COMMENTS:

NOTE (1): Words “not be grounds for automatic forfeiture” have managers advise the Board of Directors why they did not have nine players.

NOTE (2): Do not start with less than nine players.

→ Do not allow teams to borrow players from another team in order to play a game.

4.17- If during a game either team is unable to place nine (9) players on the field due to injury or ejection, the opposing manager shall select a player to re-enter the lineup. A player ejected from the game is not eligible for re-entry. If no players are available for re- entry, or if a team refuses to place nine (9) players on the field, this shall not be grounds for automatic forfeiture but shall be referred to the Board of Directors for a decision. **NOTE:** A game may not be continued with less than nine (9) players on each team.

NOTE: Opposing manager (coach in manager’s absence) picks the player to re-enter. However, any player ejected may not re-enter.

4.18 - Forfeited games shall be so recorded in the scorebook and the book signed by the umpire-in-chief. A written report stating the reason for the forfeiture shall be sent to the league president within 24 hours, but failure of the umpire to file this report shall not affect the forfeiture.

4.19 - PROTESTING GAME

- (a) Protest shall be considered only when based on the violation or interpretation of a playing rule, use of an ineligible pitcher or the use of an ineligible player. No protest shall be considered on a decision involving an umpire’s judgment. Equipment which does not meet specifications must be removed from the game. **Exception:** Illegal bat [see Rule 6.06(d)].

INSTRUCTOR COMMENTS:

→ If the batter hits a home run with an illegal bat, the batter is called out, the home run is nullified, the bat is removed from the game and the offensive team will lose one eligible adult base coach for the duration of the game. This means that the offensive team will now have to use one adult base coach and one youth base coach (Rule 4.05) for the duration of the game. The adult coach that is removed from the coaches’ box is not ejected or restricted and can be used as the one adult base coach at any time during the remainder of the game.

→ Using equipment that has already been removed from the game can result in ejection of the player and/or manager.

→ An umpire’s judgment or umpire mechanics or positioning cannot be protested.

- (b) The managers of contesting teams only shall have the right to protest a game (or in their absence, coaches). However, the manager or acting manager may not leave the dugout until receiving permission from an umpire

INSTRUCTOR COMMENTS:

→ This is why it only makes sense to talk to the managers during the pre-game conference at home plate, since they are the official representative of the team. See Rule 4.01.

(c) Protests shall be made as follows:

- (1) The protesting manager shall immediately, and before any succeeding play begins, notify the umpire that the game is being played under protest.

INSTRUCTOR COMMENTS:

→ Should this not be done, there will be no protest, regardless whether later it is discovered that a mistake may have been made.

- (2) Following such notice the umpire shall consult with the other umpire(s). If the umpire is convinced that the decision is in conflict with the rules, the umpire shall reverse that decision. If, however, after consultation, the umpire is convinced that the decision is not in conflict with the rules, said umpire shall announce that the game is being played under protest. Failure of the umpire to make such announcement shall not affect the validity of the protest.

INSTRUCTOR COMMENTS:

→ Please remember that protests only involve a violation of the Playing Rules, not judgment calls.

- (d) Protests made due to use of ineligible pitcher or ineligible player may be considered only if made to the umpire before the umpire(s) leave the field at the end of the game. Whenever it is found that an ineligible pitcher or ineligible player is being used, said pitcher shall be removed from the mound, or said player shall be removed from the game, and the game shall be continued under protest or not as the protesting manager decides.

INSTRUCTOR COMMENTS:

- The umpire(s) leaving the field means the act of physically walking off the game field. If there was a fence enclosing the field this would mean walking through the fence into a dead ball area. If there is not a fence, then when the umpire(s) have entered a dead ball area is to be considered as “leave the field”.

- (e) Any protest for any reason whatsoever must be submitted by the manager first to the umpire on the field of play and then in writing to the local league president within 24 hours. The umpire-in-chief shall also submit a report immediately.

INSTRUCTOR COMMENTS:

- There can be NO FEE attached to the submission of protest. Leagues, at times, try to put a fee into place in an effort to discourage protests. THIS CANNOT BE DONE.

[Minor Baseball & Softball: A local league may adopt a rule that protests must be resolved before the next play.]

[Tee Ball: There shall be no protests in Tee Ball.]

[Challenger: Protests are not to be considered and are not consistent with the philosophy of the Little League Challenger Division.]

- (f) A committee composed of the president, player agent, league’s Umpire-in-Chief, and one or more other officers or directors who are not managers or umpires shall hear and resolve any such protest as above, including playing rules. If the protest is allowed, resume the game from the exact point when the infraction occurred.

INSTRUCTOR COMMENTS:

- This is why presidents and player agents should not manage or umpire.
- The league’s umpire-in-chief may serve on the Protest Committee if he/she is not umpiring the protested game.
- If protest is found to be invalid, nothing else needs to be done, since the game result will stand. However, if the protest is found to be valid, there are three possible outcomes:
 - (1) Replay from the point of the protest, since the decision had a significant effect on the game’s outcome;
 - (2) Forfeit the game, if the use of an ineligible player (usually a pitcher) had a significant effect on the outcome of the game; or
 - (3) Allow the game result to remain, since the protested decision had little or no effect on the outcome of the game.

NOTE 1: This rule does not pertain to charges of infractions of regulations such as field decorum or actions of league personnel or spectators which must be considered and resolved by the Board of Directors

INSTRUCTOR COMMENTS:

- The most obvious example would be the violation of the **Mandatory Play Rule, Regulation IV (i)**.
- The youngsters should not be penalized because of the actions of the adults.

NOTE 2: All Little League officials are urged to take precautions to prevent protests. When a protest situation is imminent, the potential offender should be notified immediately. **Example:** should a manager, official scorer, league official or umpire discover that a pitcher is ineligible at the beginning of a game, or will become ineligible during the game or at the start of the next inning of play; the fact should be brought to the attention of the manager of the team involved. Such action should not be delayed until the infraction has occurred. However, failure of personnel to notify the manager of the infraction does not affect the validity of the protest.

A.R.—A substitute pitcher who is ineligible DOES NOT have to pitch to a batter. It is not a violation until the ineligible pitcher has delivered a “Pitch” as defined in Rule 2.00.

INSTRUCTOR COMMENTS:

- All league officers, umpires, scorekeepers, etc. should do everything possible to prevent protests.
- An umpire should indicate in his/her report to the Board if he/she has reason to believe that a manager knew a player was ineligible and said nothing until the situation could be protested.

- (g) **Minor League:** A local league may adopt a rule that protests must be resolved before the next pitch or play.

- (h) There are no protests in Tee Ball.

5.00- PUTTING THE BALL IN PLAY - LIVE BALL

5.01 - At the time set for beginning the game the umpire-in-chief shall order the home team to take its defensive positions and the first batter of the visiting team to take a position in the batter's box. As soon as all players are in position the umpire-in-chief shall call "Play".

[Tee Ball: When all defensive players are in position and ready the umpire will place the ball on the tee and say "Play Ball".]

5.02 - After the umpire calls "Play" the ball is alive and in play and remains alive and in play until, for legal cause, or at the umpire's call of "Time" suspending play, the ball becomes dead. While the ball is dead, no player may be put out, no bases may be run and no runs may be scored, except that runners may advance one or more bases as the result of acts which occurred while the ball was alive (such as, but not limited to an illegal pitch and/or a balk in Intermediate 50-70, Junior/Senior League -, an overthrow, interference, or a home run or other fair hit out of the playing field).

EXAMPLE: Runner on first, home plate umpire believing all play had ceased, turned his/her back on the pitcher to dust off home plate when: (a) runner steals second with no play being made; (b) pitcher catches runner standing off first talking with first base coach. Base umpire calls runner out. **Ruling:** In both (a) and (b), put runner back on first. Although neither umpire technically called "time", it was implied when the home plate umpire turned his/her back to the ball to dust off home plate. Anytime you clean the plate, call "time". **DO NOT rely on the concept of "Implied TIME"**. Then signal and call "play" to make the ball live again. See Rule 5.11.

INSTRUCTOR COMMENTS:

- The "No Pitch" signal (raising one hand up while facing the pitcher) is the same as calling "Time". If an Umpire raises one hand up while facing the pitcher he/she has called "Time Out". The ball must be made "alive" again after this "Time Out." See Rule 5.11.

5.03 - The pitcher shall deliver the pitch to the batter who may elect to strike the ball, or may not offer at it, as such batter chooses.

[CHALLENGER: (a) The ball shall be placed on the batting tee and the batter shall strike it; (b) The adult pitcher shall deliver the pitch to the batter who may elect to strike the ball, or who may not offer at it, as such batter chooses.]

5.04 - The offensive team's objective is to have its batter become a runner, and its runners advance.

5.05 - The defensive team's objective is to prevent offensive players from becoming runners, and to prevent their advance around the bases.

5.06 - When a batter becomes a runner and touches all bases legally, one run shall be scored for the offensive team.

INSTRUCTOR COMMENTS:

- Even though the rule states, "Touches all bases legally," if he/she doesn't and no appeal is made, the run scored is considered legal.

5.07 - When three offensive players are legally put out, that team takes the field and the opposing team becomes the offensive team (side retired). (**Minor League:** The side is retired when three offensive players are legally put out, or when all players on the roster have batted one time in the half-inning; or when the offensive team scores five (5) runs. (**OPTION:** The local league board of directors may suspend the five-run rule on the last half-inning for either team.) **Tee Ball:** The side is retired when three offensive players are legally put out, or when all players on the roster have batted one time in the half-inning.

INSTRUCTOR COMMENTS:

- If a team changes sides before three are put out, the official scorer may alert the umpire in order to correct the situation. Also, the part concerning Minor League and Tee Ball is a good way to get your Minor and Tee Ball games moving along so you're not there for four (4) hours

5.08 - If a thrown ball accidentally touches a base coach, or a pitched or thrown ball touches an umpire, the ball is alive and in play. However, if the coach interferes with a thrown ball, the runner is out.

Challenger: If a thrown ball accidentally touches a base coach, or a pitched or thrown ball touches a volunteer in fair territory, the ball is alive and in play. However, if a volunteer interferes with a thrown ball, the runner is out.

INSTRUCTOR COMMENTS:

- Once again, the umpire's judgment comes into play. Did the coach interfere or was he/she in the wrong place at the wrong time? If you judge interference, kill the play immediately and call the runner out.

5.09 - The ball becomes dead and runners advance one base, or return to their bases without liability to be put out, when

(a) a pitched ball touches a batter, or the batter's clothing, while in a legal batting position; runners, if forced, advance (see Rule 6.08);

INSTRUCTOR COMMENTS:

- Hands are not part of the bat, they are part of the body. Never have been and never will be a part of the bat.

(b) the plate umpire interferes with the catcher's act of throwing (when the throw is in an attempt to retire a runner), runners return. If the catcher's throw gets the runner out, the out stands. No umpire interference;

INSTRUCTOR COMMENTS:

- Remember that this assumes the catcher first catches the pitched ball cleanly. If the catcher fumbles, bobbles, drops, etc. the rule no longer applies and any interaction with the umpire would be incidental.
- If the throw gets the runner out, the umpire would announce that "the interference is disregarded," not "no interference."

(c) an illegal pitch [a balk in **Baseball: Intermediate (50-70) Division/Junior/Senior League All Division of Softball**] is committed (see Penalty 8.05);

(d) a ball is illegally batted, either fair or foul; runners return;

(e) a foul ball not caught, runners return. The umpire shall not put the ball in play until all runners have retouched their bases;

INSTRUCTOR COMMENTS:

→ Make sure each and every runner returns.

- (f) a fair ball touches a runner or an umpire on fair territory before it touches an infielder including the pitcher, or touches an umpire before it passed an infielder other than the pitcher. Runner hit by fair batted ball is out;

NOTE: If a fair ball goes through, or by an infielder and touches a runner immediately back of said infielder, or touches a runner after being deflected by an infielder, the ball is in play and the umpire shall not declare the runner out. In making such decision, the umpire must be convinced that the ball passed through, or by, the infielder and that no other infielder had the chance to make a play on the ball; runners advance if forced;

INSTRUCTOR COMMENTS:

- In Little League, the umpire should not get hit by a fair ball before it passes an infielder. The umpire does not belong in front of the infielders. However, in Intermediate 50-70, Junior/Senior League Baseball, if the ball touches an umpire after it has bounded past, or over, the pitcher, it is a dead ball.
- The concept of the runner being in jeopardy after the ball goes past an infielder and strikes the runner in a situation where another infielder still has a chance to make a play on the ball applies **ONLY** when the ball **PASSES** the first infielder without being touched or deflected by him/her. This concept **DOES NOT APPLY** if the ball is **touched** or **deflected** by the first infielder, **even though another infielder has a chance to make a play on the ball**. In other words, after a ball has been touched (deflected) by any infielder (including the pitcher), if the ball then strikes a runner (unintentionally on the part of the runner), the ball is alive and in play even if another infielder may be in position to field the ball.

- (g) a pitched ball lodges in the catcher's or umpire's mask or paraphernalia; runners advance.

INSTRUCTOR COMMENTS:

- If a pitched ball lodges in the umpire's or catcher's mask or paraphernalia, and remains out of play, on the third strike (LITTLE LEAGUE (MAJOR)/INTERMEDIATE (50/70) DIVISION/JUNIOR/SENIOR LEAGUE BASEBALL and Little League (Majors)/Junior/Senior League Softball) or fourth ball, then the batter is entitled to first base and all runners advance one base. If the count on the batter is less than three balls, runners advance one base.

- (h) **Intermediate (50-70) Division/Junior/Senior League:** Any legal pitch touches a runner trying to score; runners advance.

5.10 - The ball becomes dead when an umpire calls "Time." The Umpire-in-Chief shall call "Time" -

- (a) when in said umpire's judgment, weather, darkness or similar conditions makes immediate further play impossible

INSTRUCTOR COMMENTS:

- Remember that it's better to call a game too early, rather than too late. Calling a game too late can result in safety concerns as well as situation that may cause an umpire to revert to the previous inning
- If, as the umpire, you feel that you cannot complete a full inning, it's best not to start it.

- (b) when light failure makes it difficult or impossible for the umpires to follow the play; **NOTE:** A league may adopt its own regulations governing games interrupted by light failure.

- (c) when an accident incapacitates a player or an umpire:

INSTRUCTOR COMMENTS:

- If the umpire does call "Time" while a play is in progress, when he/she resumes play he/she must make the determination what would have occurred had he/she not suspended play? This may involve calling a runner out or advancing runners.

- (1) If an accident to a runner is such as to prevent said runner from proceeding to an entitled base, as on a home run hit out of the playing field or an award of one or more bases, a substitute runner shall be permitted to complete the play.
- (d) when a manager requests "Time" for a substitution, or for a conference with one of the players; (**NOTE:** Only one offensive time-out, for the purpose of a visit or conference, will be permitted each inning)

INSTRUCTOR COMMENTS:

- If the offensive manager requests time out to talk to the batter or runner, the defensive manager may confer with the pitcher and/or catcher without being charged with a visit.
- This, however, is not automatic. "Time" shall be granted if, in the umpire's judgment, it is necessary.

- (e) When the umpire wishes to examine the ball, consult with either manager, or for any similar cause;

- (f) when a fielder, after catching a fly ball, falls into a stand, or falls across ropes into a crowd when spectators are on the field, or other dead-ball area. As pertains to runners, the provisions of 7.04(b) shall prevail. If a fielder, after making a catch steps into a dead-ball area, but does not fall, the ball is alive and in play and runners may advance at their own peril.

EXAMPLE: A fielder, after making a catch, steps into the stands (dead ball area) but does not fall.

Ruling: The ball is in play and runners may advance at their own peril. The fielder may attempt to make a play from the dead ball area, he/she does not have to come back into live ball territory to attempt to make a play on a runner providing the fielder did not fall down while in the dead ball area

- (g) when an umpire orders a player or any other person removed from the playing field;
- (h) except in the cases stated in paragraphs (b) and (c) (1) of this rule, no umpire shall call "Time" while a play is in progress
- (i) **Softball:** the ball remains live until the umpire calls "Time."

[Tee Ball: When players have advanced as far as possible without being put out or having been retired the umpire shall call "time" and place the ball on the tee.]

5.11 - After the ball is dead, play shall be resumed when the pitcher takes position on the pitcher's plate with a new ball, or the same ball in said pitcher's possession and the plate umpire calls "Play." The plate umpire shall call "Play" as soon as the pitcher takes position on the plate with possession of the ball.

NOTE: All umpires need to do this. If you are not making the ball "alive" you need to get started.

6.00 -- THE BATTER

6.01

- (a) Each player of the offensive team shall bat in the order that their name appears in the team's batting order.
- (b) The first batter in each inning after the first inning shall be the player whose name follows that of the last player who legally completed a time at bat in the preceding inning.

NOTE: In the event that while a batter is in the batter's box, the third out of an inning is made on a base runner, the batter then at bat shall be the first batter of the next inning and the count of balls and strikes shall start over.

6.02

- (a) The batter shall take his/her position in the batter's box promptly when it is said batter's time at bat.

INSTRUCTOR COMMENTS:

→ Use this rule to help you get and keep the game moving. A friendly "let's go", "hustle", "next batter", will go a long way in keeping the game moving.

- (b) The batter shall not leave that position in the batter's box after the pitcher comes to Set Position, or starts a windup.

PENALTY: If the pitcher pitches, the umpire shall call "Ball" or "Strike" as the case may be.

INSTRUCTOR COMMENTS:

- Keep in mind, however, that with no batter present, the pitcher should be given the benefit of the doubt in this case. After all, the batter backed out without permission. It is, however, not an automatic strike. The batter leaves the batter's box at the risk of having a pitch delivered and a strike called, unless he/she requests the umpire to call "Time." The batter is not at liberty to step in and out of the batter's box at will.
- Umpires will not call "Time" at the request of the batter or any member of his/her team once the pitcher has started his/her windup or has come to a set position even though the batter claims "dust in his/her eyes," "steamed glasses," "didn't get the sign" or for any other reason.
- Umpires may grant a hitter's request for "Time" once he/she is in the batter's box, but the umpire should eliminate hitters walking out of the batter's box without reason. If umpires strictly enforce this, batters will understand that they are in the batter's box and they must remain there until the ball is pitched.
- If the pitcher delays once the batter is in the box and the umpire feels that the delay is not justified he/she may allow the batter to step out of the box momentarily.
- If after the pitcher starts his/her windup or comes to a "set position" with a runner on, and he/she does not go through with his/her pitch because the batter has stepped out of the box, it shall not be called a balk or illegal pitch. Both the pitcher and batter have violated a rule and the umpire shall call time and both the batter and pitcher start over from "scratch."

- (c) **Local League Option:** After entering the batter's box, the batter must remain in the box with at least one foot throughout the at bat.

Exceptions:

1. On a swing, slap, or check swing.
2. When forced out of the box by a pitch.
3. When the batter attempts a "drag bunt."
4. When the catcher does not catch the pitched ball.
5. When a play has been attempted.
6. When time has been called.
7. When the pitcher leaves the dirt area of the pitching mound or takes a position more than five feet from the pitcher's plate after receiving the ball or the catcher leaves the catcher's box.
8. On a three ball count pitch that is a strike that the batter thinks is a ball.

PENALTY: If the batter leaves the batter's box or delays play and none of the exceptions apply, the umpire shall warn the batter. After one warning on a batter, the umpire shall call a strike. Any number of strikes can be called on each batter. **Minor/Major Division:** No pitch has to be thrown, the ball is dead, and no runners may advance. **Intermediate (50-70) Division/Junior/Senior:** No pitch has to be thrown and ball is live.

NOTE: The batter may return to their position in the batter's box and assume the new count at any time during the at-bat, unless such enforced penalty is the third strike.

INSTRUCTOR COMMENTS:

- The warning must be repeated for every batter each time he/she comes to bat. The warnings are NOT cumulative. If the umpire issues a formal warning make sure that the batter's manager and the official scorekeeper are aware of the warning.
- The umpire shall give the batter a reasonable opportunity to take his/her proper position in the batter's box after the umpire has called a strike and before the umpire calls a successive strike.
- The ball is dead and any base runners will be required to stay on their respective base. Little League Majors and Below
- In **Intermediate 50-70, Junior, Senior League**, if the situation exists where the batter would ordinarily be allowed to run to first base on strike three, he/she will be declared out.

6.03 - The batter's legal position shall be both feet within the batter's box.

A.R.—The lines defining the box are within the batter's box.

6.04 - A batter has legally completed a time at bat when he/she is put out or becomes a runner.

6.05 - A batter is out when -

- (a) a fair or foul fly ball (other than a foul tip) is legally caught by a fielder;

A.R.—A fielder may reach into, but not step into, a dugout to make a catch, and if he/she holds the ball, the catch shall be allowed. A fielder, in order to make a catch on a foul ball nearing a dugout or other out-of-play area (such as the stands), must have one or both feet on or over the playing surface (including the dugout) and neither foot on the ground inside the dugout or in any other out-of-play area. Ball is in play, unless the fielder, after making a legal catch, falls into a dugout or other out-of-play area, in which case the ball is dead.

INSTRUCTOR COMMENTS:

→ A fielder may reach into, but not step into, a dugout to make a catch, and if he/she holds the ball, the catch shall be allowed. A fielder, in order to make a catch on a foul ball nearing a dugout or other out-of-play area (such as the stands), must have one or both feet on or over the playing surface (including the dugout) and neither foot on the ground inside the dugout or in any other out-of-play area. Ball is in play, unless the fielder, after making a legal catch, falls into a dugout or other out-of-play area, in which case the ball is dead. Status of runners shall be as described in rule 7.04(c) Instructors Comments.

- (b) **Little League (Majors) [Baseball and Softball]/Intermediate (50/70) Division [Baseball] Junior/Senior League [Baseball and Softball]**

- (1) a third strike is legally caught by the catcher;
 (2) a third strike is not caught by the catcher when first base is occupied before two are out. Minor League and Tee Ball: A third strike is caught or not caught by the catcher. Option: A local league may elect to apply the Minor and Tee Ball rule for the Little League (Major Division) for the regular season.

A.R.—(Majors/Intermediate (50-70) Division/Junior/Senior League) When a batter becomes a runner on a third strike that is not caught, and starts for the bench or his/her position, that batter may advance to first base at any time before entering the dugout or any other dead ball area. To put the batter out, the defense must tag the batter or first base before the batter touches first base.

[Tee Ball: The local league will determine whether or not strikeouts will be permitted in Tee Ball.]

INSTRUCTOR COMMENTS:

- Now in all divisions of baseball and softball, with the exception of Minor League and Tee Ball, players may advance on a third strike that is not legally caught in flight by the catcher.
 → Local leagues can opt out of this rule and apply the Minor/Tee Ball rule during the regular season. This option will only apply during the regular season. During Tournament play, the rule will be implemented as noted above for the Majors Division.
 → This rule will be in effect for play in the 10-11 Tournament Division This rule will not apply for the 9-10 Tournament Division.
 → "Legally caught," means in the catcher's glove before the ball touches the ground. It is not legal if the ball lodges in his/her clothing or paraphernalia or if it touches the umpire and is caught by the catcher on the rebound.
 → If a foul-tip first strikes the catcher's glove and then goes on through and is caught by both hands against his/her body or protector, before the ball touches the ground, it is a strike, and if third strike, batter is out. If smothered against his/her body or protector, it is a catch provided the ball struck the catchers' glove or hand first and secure possession is determined.

- (c) bunting foul on a third strike;
 (d) an Infield Fly is declared;
 (e) that batter attempts to hit a third strike and is touched by the ball;

INSTRUCTOR COMMENTS:

→ Hands are not part of the bat, they are part of the body.

- (f) a fair ball touches said batter before touching a fielder;

INSTRUCTOR COMMENTS:

→ When this happens it is almost always as a batter leaves the batter's box. Make sure the batter is entirely out of the batter's box when you call this, otherwise, call "foul ball".

- (g) after hitting or bunting a fair ball, the bat hits the ball a second time in fair territory. The ball is dead and no runner may advance. If the batter-runner drops the bat and the ball rolls against the bat in fair territory and, in the umpire's judgment there was no intention to interfere with the course of the ball, the ball is alive and in play;

A.R.—If a bat is thrown into fair or foul territory and interferes with a defensive player attempting to make a play, interference shall be called, whether intentional or not.

INSTRUCTOR COMMENTS:

- The phrase “while holding the bat” has been removed from this rule. A bat hits the ball a second time in fair territory; the batter will be called out with the ball being dead immediately and runner(s) returning or staying at their time of pitch base(s).
- Rule of thumb here is bat hits ball a second time versus ball hits bat a second time and of course, umpire’s judgment on intent to interfere.
- If a bat is thrown into fair territory and interferes with a defensive player attempting to make a play, interference shall be called, whether intentional or not.
- In cases where the batting helmet is accidentally hit, in fair territory, with a batted or thrown ball, the ball remains in play the same as if it has not hit the helmet.
- If a batted ball strikes a batting helmet or any other object foreign to the natural ground while on foul territory, it is a foul ball and the ball is dead.
- If, in the umpire’s judgment, there is intent on the part of a base runner to interfere with a batted or thrown ball by dropping the helmet or throwing it at the ball, then the runner would be out, the ball dead and runners would return to last base legally touched.

- (h) after hitting or bunting a foul ball, the batter-runner intentionally deflects the course of the ball in any manner while running to first base. The ball is dead and no runners may advance;

INSTRUCTOR COMMENTS:

- Notice that intent only applies to a batted ball in foul territory. If the batter unintentionally deflects a foul ball, he/she is not out, but the ball is dead (foul ball).

- (i) after hitting a fair ball, the batter-runner or first base is tagged before said batter-runner touches first base; or Little League **Little League (Majors) [Baseball and Softball]/Intermediate (50/70) Division [Baseball] Junior/Senior League [Baseball and Softball]**, after a third strike as defined in Rule 6.09(b), the batter-runner or first base is tagged before said batter-runner touches first base;
- (j) in running the last half of the distance from home base to first base, while the ball is being fielded to first base, the batter- runner runs outside (to the right of) the three-foot line, or inside (to the left of) the foul line, and in the umpire’s judgment in so doing interferes with the fielder taking the throw at first base; except that the batter-runner may run outside (to the right of) the three-foot line, or inside (to the left of) the foul line to avoid a fielder attempting to field a batted ball;

A.R.—The lines marking the three-foot lane are a part of that lane and a batter-runner is required to have both feet within the three foot lane or on the lines marking the lane.

EXAMPLE: Batter-runner hits a ground ball to the shortstop who throws to first. The throw pulls the first baseman up the line where he/she and the batter-runner collide. **Ruling: The call is “That’s Nothing”** *What you have is a collision. Batter-runner was not out of baseline.*

INSTRUCTOR COMMENTS:

- The lines marking the three-foot lane are a part of that lane and a batter-runner is required to have both feet within the three-foot lane or on the lines marking the lane. The batter-runner is permitted to exit the three-foot lane by means of a step, stride, reach or slide in the immediate vicinity of first base for the sole purpose of touching first base.
- It’s always interference if the catcher’s or pitcher’s throw hits the batter-runner when he/she is not in the “lane”. The lines that mark the “lane” are part of the “lane” and the interpretation to be made is that a runner is required to have both feet within the three foot “lane” or on the lines marking the “lane.” If the throw is accurate to the first baseman and in the umpire’s judgment the runner interfered with the first baseman, it is interference.
- There are two key elements to this rule that frequently are misunderstood: (1) the ball must be thrown in order for the runner to interfere with the “fielder taking the throw” and (2) the throw must be a reasonably catchable throw. A catcher who does not throw, or who throws well over the fielder’s head should not be rewarded by having interference called.
- A “catchable throw” would essentially be a throw that the baseman could catch it if the runner were not there.
- This, most often, will be the plate umpire’s call, since the base umpire will be moving into position to make the call at first. However, understand that either umpire may make the call.

- (k) an infielder intentionally drops a fair fly ball or line drive, with first; first and second, first and third, or first, second and third bases occupied before two are out. The ball is dead and runner or runners shall return to their original base or bases;

A.R. – In this situation, the batter is not out if the infielder permits the ball to drop untouched to the ground, except when the Infield Fly rule applies.

INSTRUCTOR COMMENTS:

- If the fly ball touches a hand and/or glove and falls to the ground, rule intentionally dropped “dead ball, batter out and runner or runners shall return”. **Exception:** Infield Fly rule takes precedence over the intentionally dropped ball and it remains alive and in play.

- (l) a preceding runner shall, in the umpire’s judgment, intentionally interferes with a fielder who is attempting to catch a thrown ball or to throw a ball in an attempt to complete a play.

INSTRUCTOR COMMENTS:

- The reason for this rule is to penalize the offensive team for deliberate, unwarranted, unsportsmanlike action by the runner in leaving the baseline for the obvious purpose of crashing the pivot man on a double play, rather than trying to reach the base. Obviously this is an umpire's judgment play.

- (m) **Baseball: Intermediate (50-70) Division/Junior/Senior League:** With two out, a runner on third base, and two strikes on the batter, the runner attempts to steal home base on a legal pitch and the ball touches the runner in the batter's strike zone. The umpire shall call "Strike Three," the batter is out and the run shall not count; before two are out, the umpire shall call "Strike Three," the ball is dead, and the run counts.

6.06 - A batter is out for illegal action when -

- (a) hitting the ball with one or both feet on the ground entirely outside the batter's box;

A.R.—If a batter hits a ball fair or foul while out of the batter's box, he/she shall be called out.

INSTRUCTOR COMMENTS:

- This call is **NEVER** the responsibility of the base umpire. The plate umpire, only, is responsible.

- (b) stepping from one batter's box to the other while the pitcher is in position ready to pitch;

INSTRUCTOR COMMENTS:

- This is intended to prevent the batter from jumping from one side to the other, thereby confusing the defense, not when the batter happens to step across home plate when first arriving for his/her at bat.

- (c) interfering with the catcher's fielding or throwing by:

- (1) stepping out of the batter's box, or;
- (2) making any other movement that hinders the catcher's actions at home plate or the catcher's attempt to play on a runner, or;
- (3) failing to make a reasonable effort to vacate a congested area when there is a throw to home plate and there is time for the batter to move away.

EXCEPTION: Batter is not out if any runner attempting to advance is put out, or if runner trying to score is called out for batter's interference.

INSTRUCTOR COMMENTS:

- Notice that there is no mention of intentional. Again, umpire's judgment.
- If the batter interferes with the catcher, the plate umpire shall call "interference." The batter is out and the ball dead. No player may advance on such interference (offensive interference) and all runners must return to the last base that was, in the judgment of the umpire, legally touched at the time of the interference.
- If, however, the catcher makes a play and the runner attempting to advance is put out, it is to be assumed there was no actual interference and that runner is out--not the batter. Any other runners on the base at the time may advance, as the ruling is that there is no actual interference if a runner is retired. In that case play proceeds just as if no violation had been called.
- If a batter strikes at a ball and misses and swings so hard he/she carries the bat all the way around and, in the umpire's judgment, unintentionally hits the catcher or the ball in back of him/her on the back swing before the catcher has securely held the ball, it shall be called a strike only (not interference). The ball will be dead, however, and no runner shall advance on the play.
- While this rule will most often come into play in the **Intermediate (50/70), Junior, Senior League Baseball and Little League (Major), Junior, Senior League Softball programs**, it can occur in all divisions on passed balls or wild pitches. The batter must avoid interference. Period

- (d) The batter enters the batter's box with one or both feet entirely on the ground with an illegal bat (see bat specifications Rule 1.10) or is discovered having used an illegal bat prior to the next player entering the batter's box. The ball is dead. Runners must return if they advanced on the play.

A.R.—When an illegal bat is discovered, it **MUST** be removed from the game at that point

Note: If the infraction is discovered before the next player enters the batter's box following the turn at bat of the player who used an illegal bat:

- (1) The manager of the defense may advise the plate umpire of a decision to decline the penalty and accept the play. Such Election shall be made immediately at the end of the play.
- (2) For the first violation the offensive team will lose one eligible adult base coach for the duration of the game.

A.R.—Any of the three adults in the dugout may be used as the one adult base coach at any time during the duration of the game.

- (3) For the second violation, the manager of the team will be ejected from the game. Any subsequent violation will result in the newly designated manager being ejected

INSTRUCTOR COMMENTS:

- ➔ If an illegal bat (does not meet specifications of any variety) is discovered during the equipment inspection before the game, the bat is to be removed from the dugout at this time and no further penalty will be assessed to the player, coach or manager. It should be the manager's responsibility to make sure the bat is removed from the dugout, so the umpire should ask the manager to remove the bat so that it cannot inadvertently be used later in the game.
- ➔ Once the equipment has been inspected and the game starts and a player enters the batter's box (one or both feet entirely on the ground within the batter's box) and it is discovered that he/she is using an illegal bat, the player is called out, the bat is removed from the game and the offensive team will lose one eligible adult base coach for the duration of the game for the first violation and if it is a second violation, the manager will be ejected and will be subject to the penalty for the ejection under Rule 4.07.
- ➔ Once a player has completed a time at bat using an illegal bat and the next batter enters the batter's box and then it is discovered that the prior batter had used an illegal bat, the only penalty at this time is to remove the bat from the game.
- ➔ Once a player completes a time at bat and then it is discovered that he/she had used an illegal bat and the manager opts to take the penalty, all action resulting from the batter using the illegal bat is nullified; any runner/s must return to their Time of Pitch base; the batter is called out; the bat is removed from the game and the offensive team will lose one eligible adult base coach for the duration of the game.
- ➔ When a player uses an illegal bat and completes a time at bat and the manager elects to take the play instead of the penalty, all action resulting from that batter's time at bat will stand; the bat will be removed from the game; the batter will not be called out for the use of an illegal bat but the coach will be subject to the penalty of being removed from the coaches' box if it is discovered before the next batter enters the batter's box
- ➔ An eligible adult coach who has been removed from the coaches box for a violation of this rule, is not ejected from the game or restricted, as the penalty is position specific and not person specific, any of the three adults in the dugout may be used as the one adult base coach at any time during the duration of the game.
- ➔ If a player uses an illegal bat while batting out of order; completes a time at bat, and before the next batter enters the batter's box, it is discovered he/she used an illegal bat and the manager accepts the penalty, and then appeals that to umpire that the batter was batting out of order, under Rule 6.07, trying to get two outs out of this situation the manager will have to pick between the two violations. We will not allow the defensive team to get two outs, the manager will pick which one of the violations he/she wants enforced. If he/she picks the violation under Rule 6.06 (d) then the action from the time at bat is nullified; the batter is called out; the bat is removed from the game and the offensive team will lose an eligible adult base coach for the duration of the game. If he/she picks the violation under Rule 6.07 (batting out of order) then any action resulting from the improper batter's time at bat is nullified; the proper batter is called out; the bat is removed from the game and the next batter to bat is the batter who follows the called out proper batter.
- ➔ If a player steps into the batter's box with an illegal bat which is discovered before he/she completes a time at bat, the batter is called out; the bat is removed and the offensive coach is removed from the coaches box. If at this point it is discovered that the batter was also batting out of order, it should be treated as if the batting out of order was not discovered and the next batter would be the proper batter listed on the lineup.
- ➔ The main part of this rule and the penalties associated with it, is that no matter what happens or what penalties are assessed, when an illegal bat is discovered it MUST be removed from the game at that point. So this why we say if we as umpires do a thorough and vigilant inspection of all the equipment before each and every game, we can prevent a lot of these problems and situations from occurring.

6.07 - BATTING OUT OF TURN

- (a) A batter shall be called out, on appeal, when failing to bat in his/her proper turn, and another batter completes a time at bat in place of the proper batter.
- (1) The proper batter may take a position in the batter's box at any time before the improper batter becomes a runner or is put out, and any balls and strikes shall be counted in the proper batter's time at bat.

EXAMPLE: After the wrong batter works the count to 0-2, the offensive manager realizes the mistake and gets the proper batter up at bat.
Ruling: The umpire should inform the proper batter he/she has a 0-2 count and then call "Play". No other penalty is given.

- (b) When an improper batter becomes a runner or is put out, and the defensive team appeals to the umpire before the first pitch to the next batter of either team, or before any play or attempted play, the umpire shall
- (1) declare the proper batter out; and
- (2) nullify any advance or score made because of a ball batted by the improper batter or because of the improper batter's advance to first base on a hit, an error, a base on balls, a hit batter or otherwise.

NOTE: If a runner advances while the improper batter is at bat, on a stolen base, wild pitch [**Baseball: Intermediate (50-70) Division/Junior/Senior League:** balk], or passed ball, such advance is legal.

EXAMPLE: Bases loaded, one out, or two outs, wrong batter steps into the box and strokes a triple, defense appeals, how many runs scored?

Ruling: *With one out, umpire calls out correct batter and returns all runners to the base they occupied at time of hit, no runs scored; with two outs, the umpire calls out correct batter for the third out and no runs scored.*

INSTRUCTOR COMMENTS:

- ➔ Appeal must be made before the next pitch, play or attempted play. **Baseball** and **Softball** treat this element differently. In **Baseball**, a fake throw is **NOT** considered an attempted play. However, in **Softball**, if the pitcher is in the eight-foot circle, a fake throw **IS** considered an attempted play for consideration of the circle rule. See **Rule 7.10** also.

- (c) When the improper batter becomes a runner or is put out, and a pitch is made to the next batter of either team before an appeal is made, the improper batter thereby becomes the proper batter, and the results of such time at bat become legal.

EXAMPLE: Batting order Abbey, Beverly, Calvin, and Danny. Beverly mistakenly bats for Abbey. After a pitch is delivered to Calvin the defensive manager notifies you that Beverly batted out of order. **Ruling:** No Call. Because Calvin has taken a pitch, Beverly's at bat is legal and Calvin continues his at bat.

- (d) (1) When the proper batter is called out for failing to bat in turn, the next batter shall be the batter whose name follows that of the proper batter thus called out;
- (2) When an improper batter becomes a proper batter because no appeal is made before the next pitch, the next batter shall be the batter whose name follows that of such legalized improper batter. The instant an improper batter's actions are legalized, the batting order picks up with the name following that of the legalized improper batter.

[Tee Ball only: The scorekeeper shall inform the manager that a player has batted out of order. There shall be no penalty and that player shall not have another turn at bat, but shall resume the normal position next time up.]

[CHALLENGER: A player batting out of turn shall not be cause for an out to be declared but shall be corrected in the following inning.]

INSTRUCTOR COMMENTS:

- ➔ Scorekeepers and umpires should never call attention to either team that a player is batting out of turn. It is an appeal play that must be discovered by the opposing team. This rule is designed to require managers and coaches from both teams to pay attention to who should bat and who is batting. The game cannot be protested if the scorekeeper says something. The scorekeeper should, however, be counseled as to his/her responsibilities.
- ➔ There are two basic things about the rule to keep in mind: When a player bats out of turn, the proper batter is the player called out. If an improper batter bats and reaches base or is out and no appeal is made before a pitch to the next batter, or before any play or attempted play, that improper batter is considered to have batted in proper turn and establishes the order that is to follow.
- ➔ In games where announcers are used, have the announcer only announce the player who is physically stepping into the batter's box, not the player who is due up to bat. By announcing who is due up, he/she would be "giving away" to the opposing team that a player is batting out of turn.
- ➔ A player who is called out, on appeal, for failing to bat is considered as satisfying the Mandatory Play Rule, Regulation IV (i) and an at-bat for the purpose of Rule 3.30. Further, a player "skipped over" as a result of a player batting out of turn with no appeal has not satisfied Regulation IV (i) or Rule 3.03.

BATTING OUT OF TURN APPROVED RULINGS

To illustrate various situations arising from batting out of turn, assume a first-inning batting order as follows:

Baseball: Abel - Baker - Charles - Daniel - Edward - Frank - George - Henry - Irwin.

Softball: Ann - Becky - Cher - Diane - Erin - Fran - Ginny - Heather - Irene

PLAY (1). Baker (*Becky*) bats. With the count 2 balls and 1 strike, (a) the offensive team discovers the error or (b) the defensive team appeals.

RULING: In either case, Abel (*Ann*) replaces Baker (*Becky*), with the count 2 balls and 1 strike.

PLAY (2). Baker (*Becky*) bats and doubles. The defensive team appeals (a) immediately or (b) after a pitch to Charles (*Cher*).

RULING: (a) Abel (*Ann*) is called out and Baker (*Becky*) is the proper batter; (b) Baker (*Becky*) stays on second and Charles (*Cher*) is the proper batter.

PLAY (3). Abel (*Ann*) walks. Baker (*Becky*) walks. Charles (*Cher*) forces Baker (*Becky*). Edward (*Erin*) bats in Daniel's (*Diane's*) turn. While Edward (*Erin*) is at bat, Abel (*Ann*) scores and Charles (*Cher*) goes to second on a wild pitch. Edward (*Erin*) grounds out, sending Charles (*Cher*) to third. The defensive team appeals (a) immediately or (b) after a pitch to Daniel (*Diane*).

RULING: (a) Abel's (*Ann's*) run counts and Charles (*Cher*) is entitled to second base since these advances were not made because of the improper batter batting a ball or advancing to first base Charles (*Cher*) must return to second base because the advance to third resulted from the improper batter batting a ball. Daniel (*Diane*) is called out and Edward (*Erin*) is the proper batter; (b) Abel's (*Ann's*) run counts and Charles (*Cher*) stays on third. The proper batter is Frank (*Fran*).

PLAY (4). With the bases full and two out, Henry (*Heather*) bats in Frank's (*Fran's*) turn, and triples, scoring three runs. The defensive team appeals (a) immediately or (b) after a pitch to George (*Ginny*).

RULING: (a) Frank (*Fran*) is called out and no runs score. George (*Ginny*) is the proper batter to lead off the second inning; (b) Henry (*Heather*) stays on third and three runs score. Irwin (*Irene*) is the proper batter.

PLAY (5). After Play (4) (b) above, George (*Ginny*) continues to bat. (a) Henry (*Heather*) is picked off third base for the third out, or (b) George (*Ginny*) flies out, and no appeal is made. Who is the proper lead off batter in the second inning?

RULING: (a) Irwin (*Irene*) became the proper batter as soon as the first pitch to George (*Ginny*) legalized Henry's (*Heather's*) triple; (b) Henry (*Heather*). When no appeal was made, the first pitch to the lead off batter of the opposing team legalized George's (*Ginny's*) time at bat.

PLAY (6). Daniel (*Diane*) walks and Abel (*Ann*) comes to bat. Daniel (*Diane*) was an improper batter and if an appeal is made before the first pitch to Abel (*Ann*), Abel (*Ann*) is out, Daniel (*Diane*) is removed from base, and Baker (*Becky*) is proper batter. There is no appeal and a pitch is made to Abel (*Ann*). Daniel's (*Diane's*) walk is now legalized, and Edward (*Erin*) thereby becomes the proper batter. Edward (*Erin*) can replace Abel (*Ann*) at any time before Abel (*Ann*) is put out, or becomes a runner. Edward (*Erin*) does not do so. Abel (*Ann*) flies out, and Baker (*Becky*) comes to bat. Abel (*Ann*) was an improper batter, and if an appeal is made before the first pitch to Baker (*Becky*), Edward (*Erin*) is out, and the proper batter is Frank (*Fran*). There is no appeal, and a pitch is made to Baker (*Becky*). Abel's (*Ann's*) out is now legalized, and the proper batter is Baker (*Becky*). Baker (*Becky*) walks. Charles (*Cher*) is the proper batter. Charles (*Cher*) flies out. Now Daniel (*Diane*) is the proper batter, but Daniel (*Diane*) is on second base. Who is the proper batter?

RULING: The proper batter is Edward (*Erin*). When the proper batter is on base, that batter is passed over, and the following batter becomes the proper batter.

(NOTE: The umpire and scorekeeper shall not direct the attention of any person to the presence in the batter's box of an improper batter. This rule is designed to require constant vigilance by the players and managers of both teams. There are two fundamentals to keep in mind. 1. When a player bats out of turn, the proper batter is the player called out. 2. If an improper batter bats and reaches base or is out and no appeal is made before a pitch to the next batter, or before any play or attempted play, that improper batter is considered to have batted in his/her proper turn and establishes the batting order that is to follow.)

Tee Ball: The scorekeeper shall inform the manager that a player has batted out of order. There shall be no penalty and that player shall not have another turn at bat, but shall resume the normal position next time up.

6.08 - The batter becomes a runner and is entitled to first base without liability to be put out (provided said runner advances to and touches first base) when -

- (a) (1) four "Balls" have been called by the umpire; the ball is live and in play. Base runners may advance;
- (2) **Baseball: Minor/Major Division:** prior to a pitch being thrown, the defense elects to "Intentionally Walk" the batter by announcing such decision to the plate umpire.

NOTE 1: Such notification must be made by the defensive manager. The manager must request and be granted “time” by the umpire and then inform the umpire of the defense’s intent to walk the batter.

NOTE 2: The ball is dead and no other runners may advance unless forced by the batter’s award. Four (4) pitches will be added to the pitch count.

- (b) the batter is touched by a pitched ball which the batter is not attempting to hit unless (1) The ball is in the strike zone when it touches the batter, or (2) the batter makes no attempt to avoid being touched by the ball;

NOTE: If the ball is in the strike zone when it touches the batter, it shall be called a strike, whether or not the batter tries to avoid the ball. If the ball is outside the strike zone when it touches the batter, it shall be called a ball if that batter makes no attempt to avoid being touched.

A.R.—When the batter is touched by a pitched ball which does not entitle that batter to first base, the ball is dead and no runner may advance.

INSTRUCTOR COMMENTS:

→ Do not get talked into buying the old “The hands are part of the bat” myth.

- (c) the catcher or any fielder interferes with the batter. If a play follows the interference, the manager of the offense may advise the plate umpire of a decision to decline the interference penalty and accept the play. Such election shall be made immediately at the end of the play. However, if the batter reaches first base on a hit, an error, a base on balls, a hit batsman, or otherwise, and all runners advance at least one base, the play proceeds without reference to the interference;

(Baseball)

A.R. 1—**Intermediate (50-70) Division/Junior/Senior League:** If a runner is trying to score by a steal or squeeze from third base, note the additional penalty set forth in Rule 7.07.

A.R. 2—If the catcher interferes with the batter before the pitcher delivers the ball, it shall not be considered interference on the batter under Rule 6.08(c). In such cases, the umpire shall call “Time” and the pitcher and batter resume the count.

INSTRUCTOR COMMENTS:

- When giving a manager a choice of plays, word it in such a way that he/she knows what the correct answer is for his/her team.
- The umpire is responsible for enforcing the penalty for interference if all runners, including the batter-runner, fail to advance one base. The manager or umpire can and should initiate the option discussion. When the options are discussed they should be given so the manager understands the best answer for his/her team.
- If catcher’s interference is called with a play in progress the umpire will allow the play to continue because the manager may elect to take the play. If the batter-runner missed first base, or a runner misses his/her next base, he/she shall be considered as having reached the base, as stated in **Note of Rule 7.04(c)**.
- Examples of plays the manager might elect to take: (1) Runner on third, one out, batter hits fly ball to the outfield on which the runner scores but catcher’s interference was called. The offensive manager may elect to take the run and have batter called out or have the runner remain at third and batter awarded first base. (2) Runner on second base. Catcher interferes with batter as he/she bunts ball fairly sending runner to third base as the defense gets the out at 1st. The manager may rather have a runner on third base with an out on the play than have runners on second and first.
- In situations where the manager wants the “interference” penalty to apply, the following interpretation shall be made of **6.08(c)**:
- If the catcher (or any fielder) interferes with the batter, the batter is awarded first base. If, on such interference a runner is trying to score by a steal or squeeze from third base, the ball is dead and the runner on third scores and batter is awarded first base. If the catcher interferes with the batter with no runners trying to score from third on a squeeze or steal, then the ball is dead, batter is awarded first base and runners who are forced to advance, do advance. Runners not attempting to steal or not forced to advance remain on the base they occupied at the time of the interference.
- If the catcher interferes with the batter before the pitcher delivers the ball, it shall not be considered interference on the batter under **Rule 6.08(c)**. In such cases, the umpire shall call “Time” and the pitcher and batter start over from “scratch.”

- (d) a fair ball touches an umpire or a runner on fair territory before touching a fielder.

A.R.—Ball is dead. Runner(s) who are forced advance and any runners not forced will return to their bases at the time of the pitch.

NOTE: If a fair ball touches an umpire after having passed a fielder other than the pitcher, or having touched a fielder, including the pitcher, the ball is in play.

INSTRUCTOR COMMENTS:

- Correct call is time, award bases. The ball will be dead when time is called.
- Only runners forced to advance are awarded a base in this situation.

6.09 - The batter becomes a runner when-

- (a) a fair ball is hit;

[CHALLENGER: A ball hit off the tee may be declared foul if it fails to travel beyond the 15 foot arc in fair territory.]

- (b) **Little League Majors (Baseball and Softball)/ Intermediate (50-70) Division (Baseball) Junior/Senior League (Baseball/Softball):** the third strike called by the umpire is not caught, providing (1) first base is unoccupied or (2) first base is occupied with two out; **(NOTE: A batter forfeits his/her opportunity to advance to first base when he/she enters the dugout or other dead ball area.)**

INSTRUCTOR COMMENTS:

- Sometimes, the batter will take a few steps toward the dugout or his/her defensive position after the third strike without realizing that he/she can advance to first base. This would be perfectly legal. The batter is not "out of the baseline" or has not "abandoned his/her base" or any other explanation that the opposing manager will give you.

- (c) A fair ball, after having passed a fielder other than the pitcher, or after having been touched by a fielder, including the pitcher, shall touch an umpire or runner in fair territory;
- (d) A fair fly ball passes over a fence or into the stands at a distance from home base of 165 feet [**Intermediate (50-70) Division (Baseball) 200 Feet; and Junior/Senior League (Baseball): 250 feet**] or more. Such hit entitles the batter to a home run when all bases have been legally touched. A fair fly ball that passes out of the playing field at a point less than 165 feet [**Intermediate (50-70) Division (Baseball) 200 Feet**] [**Junior/Senior League (Baseball): 250 feet**] from home base shall entitle the batter to advance to second base only;
- (e) any fair ball which, either before or after touching the ground, passes through or under a fence, through or under a scoreboard, through any opening in the fence or scoreboard, through or under shrubbery or vines on the fence, or which sticks in a fence or scoreboard, in which case the batter and the runners shall be entitled to two bases;
- (f) any fair ball which, either before or after touching the ground, passes through or under a fence, through or under a scoreboard, through any opening in the fence or scoreboard, through or under shrubbery or vines on the fence, or which sticks in a fence or scoreboard, in which case the batter and the runners shall be entitled to two bases;
- (g) any bounding fair ball is deflected by the fielder into the stands, or over or under a fence on fair or foul territory, in which case the batter and all runners shall be entitled to advance two bases;
- (h) any fair fly ball is deflected by the fielder into the stands, or over the fence into foul territory, in which case the batter shall be entitled to advance to second base; but if deflected into the stands or over the fence in fair territory, the batter shall be entitled to a home run. However, should such a fair fly be deflected at a point less than 165 feet [**Intermediate (50-70) Division (Baseball) 200 feet and Junior/Senior League (Baseball): 250 feet**] from home plate, the batter shall be entitled to two bases only.

INSTRUCTOR COMMENTS:

- If a fair fly ball is deflected by the defensive player over the fence in fair territory, it shall be ruled a home run, since, by definition, the ball has left the playing field "in flight."

7.00-- THE RUNNER

7.01- A runner acquires the right to an unoccupied base when that runner touches it before being put out. The runner is then entitled to it until put out or forced to vacate it for another runner legally entitled to that base. If a runner legally acquires title to a base, and the pitcher assumes his/her position on the pitcher's plate, the runner may not return to a previously occupied base.

INSTRUCTOR COMMENTS:

- If a runner tries to retreat to a previously occupied base while the pitcher is on the pitcher's plate, the umpire will call "Time" and declare the runner out.

7.02 - In advancing, a runner shall touch first, second, third and home base in that order. If forced to return, the runner shall retouch all bases in reverse order, unless the ball is dead under any provision of Rule 5.09. In such cases, the runner may go directly to the original base.

INSTRUCTOR COMMENTS:

- A runner who misses a base is considered as having touched a base if the opposing team makes no appeal.

7.03 - Two runners may not occupy a base, but if, while the ball is alive, two runners are touching the base, the following runner shall be out when tagged. The preceding runner is entitled to the base.

INSTRUCTOR COMMENTS:

- Enforce 7.03 provided there is no force involved.

7.04 - Each runner, other than the batter, may without liability to be put out, advance one base when -

- (a) the batter's advance without liability to be put out forces the runner to vacate a base, or when the batter hits a fair ball that touches another runner or the umpire before such ball has been touched by, or has passed a fielder, if the runner is forced to advance, or in [**Intermediate (50/70) Division/Junior/Senior League Baseball**], there is a balk; Junior/Senior Softball, there is an illegal pitcher

INSTRUCTOR COMMENTS:

- A runner forced to advance without liability to be put out may advance past the base to which he/she is entitled only at his/her peril. If such a runner, forced to advance, is put out for the third out before a preceding runner, also forced to advance, touches home plate, the run shall score. Play. Two outs, bases loaded, batter walks but runner from second is overzealous and runs past third base toward home and is tagged out on a throw by the catcher. Even though two are out, the run would score on the theory that the run was forced home by the base on balls and that all the runners needed to do was proceed and touch the next base.

- (b) a fielder, after catching a fly ball, falls into a stand, or falls across ropes into a crowd when spectators are on the field, or falls into other dead-ball areas;

INSTRUCTOR COMMENTS:

- If a fielder, after having made a legal catch, should fall into a stand or among spectators or into the dugout or any other out-of-play area while in possession of the ball after making a legal catch, or fall while in the dugout after making a legal catch, the ball is dead and each runner shall advance one base, without liability to be put out, from his last legally touched base at the time the fielder fell into, or in, such out-of-play area,
- Note that this is for a **BATTED** fly ball only. A batted bouncing ball is covered by 7.05 (f) and a thrown ball by 7.05 (g).

- (c) **Intermediate (50/70) Division/Junior/Senior League Baseball** while the runner is attempting to steal a base, the batter is interfered with by the catcher or any other fielder.

NOTE: When a runner is entitled to a base without liability to be put out, while the ball is in play, or under any rule in which the ball is in play after the runner reaches an entitled base, and the runner fails to touch the base to which that runner is entitled before attempting to advance to the next base, the runner shall forfeit the exemption from liability to be put out and may be put out by tagging the base or by tagging the runner before that runner returns to the missed base.

A.R.—A runner forced to advance without liability to be put out, may advance past the base to which he/she is entitled at his/her own risk.

- **Example - Comment:** A runner forced to advance without liability to be put out, may advance past the base to which he/she is entitled at his/her own risk.

7.05 – Each runner including the batter-runner may, without liability to be put out advance,

- (a) to home base scoring a run, if a fair ball goes out of the playing field in flight and the runner touches all bases legally; or if a fair ball which, in the umpire's judgment would have gone out of the playing field in flight (165 feet from home plate; **Intermediate (50/70) Division: 200 feet and Junior/Senior League Baseball** 250 feet), is deflected by the act of a fielder in throwing a glove, cap, or any article of apparel;

- **Example - Comment:** If this call is made, also warn the player that is throwing the glove, cap, or an article of apparel. That defensive player is making a travesty of the game.

- (b) Three bases, if a fielder deliberately touches a fair ball with a cap, mask or any part of that fielder's uniform detached from its proper place on the person of said fielder. The ball is in play and the batter may advance to home base at the batter's peril;

Example: - Play 7-1: With his/her team way ahead, an infielder decides to showboat for his girlfriend in the stands. He glides under a soft pop-fly and catches it in his hat. Meanwhile, the batter races for second. Ruling: Batter is entitled to third base and ball remains in play

- (c) Three bases, if a fielder deliberately throws a glove and touches a fair ball. The ball is in play and the batter may advance to home base at that batter's own peril;

INSTRUCTOR COMMENTS:

→ The glove must touch the ball, merely throwing the glove in itself is not against the rule. The act must be deliberate, not accidental. This penalty shall not be invoked against a fielder whose glove is carried off his/her hand by the force of a batted or thrown ball, or when his/her glove flies off his/her hand as he/she makes an obvious effort to make a legitimate catch. The ball remains alive and in play and the runner may advance to home if he/she wishes. Do not call "Time" when this act occurs.

- (d) Two bases, if a fielder deliberately touches a thrown ball with a cap, mask or any part of the uniform detached from its proper place on the person of said fielder. The ball is in play;
- (e) Two bases, if a fielder deliberately throws a glove and touches a thrown ball. The ball is in play;
- (f) Two bases, if a fair ball bounces or is deflected into the stands outside the first or third base foul line; or if it goes through or under a field fence, or through or under a scoreboard, or through or under shrubbery or vines on the fence; or if it sticks in such fence, scoreboard, shrubbery or vines;
- (g) Two bases when with no spectators on the playing field, a thrown ball goes into the stands, or into a bench (whether or not the ball rebounds into the field), or over or under or through a field fence, or on a slanting part of the screen above the backstop, or remains in the meshes of wire screen protecting spectators. The ball is dead. When such wild throw is the first play by an infielder, the umpire, in awarding such bases, shall be governed by the position of the runners at the time the ball was pitched; in all other cases the umpire shall be governed by the position of the runners at the time the wild throw was made;

A.R. —If all runners, including the batter-runner have advanced at least one base when an infielder makes a wild throw on the first play after the pitch, the award shall be governed by the position of the runners when the wild throw was made;

EXAMPLE: Position of the runners when the wild throw is released dictates where they are placed.

Play: Runner on first, batter grounds to the shortstop who bobbles the ball long enough for a runner on first to get to second and batter-runner to get to first at which time he/she throws the ball into a dead ball area. What are the awards? **Ruling:** All (both) runners have advanced at least one base when wild throw was released, award home to runner and third to batter-runner.

Play: On a ball hit to right field, the runner on first rounds second and the batter rounds first. The right fielder throws behind the runner at first and the ball goes out of play. **Ruling:** Runner at second gets home and the batter-runner goes to third. (Time of the throw is the key!)

- (h) One base, if a ball, pitched to the batter, or thrown by the pitcher from the position on the pitcher's plate to a base to catch a runner goes into a stand or a bench, or over or through a field fence or backstop. The ball is dead;
- (i) One base, if the batter becomes a runner on ball four when the pitch passes the catcher and lodges in the umpire's mask or paraphernalia.

[Little League (Majors) [Baseball and Softball]/Intermediate (50/70) Division [Baseball] Junior/Senior League [Baseball and Softball] one base, if the batter becomes a runner on ball four or strike three when the pitch passes the catcher and lodges in the umpire's mask or paraphernalia.

INSTRUCTOR COMMENTS:

- Both (h) and (i) pertain to a "dead ball" situation.
- The fact a runner is awarded a base or bases without liability to be put out does not relieve him/her of the responsibility to touch the base he/she is awarded and all intervening bases. For example: batter hits a ground ball that an infielder throws into the stands but the batter-runner missed first base. If he/she fails to touch first base on his/her way to second base he/she may be called out on appeal for missing first base after the ball is put in play even though he/she was "awarded" second base.
- If a runner is forced to return to a base after a catch, he/she must retouch his/her original base even though, because of some ground rule or other rule, he/she is awarded additional bases. He/she may retouch while the ball is dead and the award is then made from his/her original base.

NOTE 1: If the batter becomes a runner on a wild pitch which entitles the runners to advance one base, the batter-runner shall be entitled to first base only but can advance beyond first base at their own risk if the ball stays in play.

NOTE 2: In Tee Ball, the runner or runners will be permitted to advance at their own risk on an overthrow that remains in play, but not more than one base.

Rule of thumb: Always remember on base awards "One from the pitcher's plate and two from the field."

- (j) One base, if a fielder deliberately touches a pitched ball with his/her cap, mask or any part of his/her uniform detached from its proper place on his/her person. The ball is in play, and the award is made from the position of the runner at the time the ball was touched.

7.06 – When the obstruction occurs the umpire shall call or signal “Obstruction.”

- (a) If a play is being made on the obstructed runner, or if the batter-runner is obstructed before touching first base, the ball is dead and all runners shall advance without liability to be put out, to the bases they would have reached, in the umpire’s judgment, if there had been no obstruction. The obstructed runner shall be awarded at least one base beyond the base last legally touched by such runner, before the obstruction. Any preceding runners forced to advance by the award of bases as the penalty for obstruction shall advance without liability to be put out

INSTRUCTOR COMMENTS:

→ When a play is being made on an obstructed runner, the umpire shall Call “Time”, identify the defensive player who did the obstruction and award base(s) accordingly. The ball is immediately dead when this signal is given; however, should a thrown ball be in flight before the obstruction is called by the umpire, the runners are to be awarded such bases on wild throws as they would have been awarded had the obstruction not occurred.

→ On a play where a runner was trapped between second and third and obstructed by the third baseman going into third base while the throw is in flight from the shortstop, if such throw goes into the dugout the obstructed runner is to be awarded home base. Any other runners on base in this situation would also be awarded two bases from the base they last legally touched before obstruction was called.

EXAMPLE: - Play: Batter hits a slow roller down the first base line. Pitcher, thinking he/she has a play, hustles to the line to try and field the batted ball. The ball gets past the pitcher before he/she can get to it, but he/she inadvertently runs into the runner

Ruling: *As soon as you judge obstruction, kill the play. Throw your hands above your head and call “time”. Then announce “obstruction”. Award bases accordingly*

→ Remember that it makes no difference which direction the runner is running when he/she is obstructed. He/she is awarded at least one base beyond the one last legally touched before the obstruction

- (b) If no play is being made on the obstructed runner, the play shall proceed until no further action is possible. The umpire shall then call “Time” and impose such penalties, if any, as in that umpire’s judgment will nullify the act of obstruction. (**NOTE 1:** When the ball is not dead on obstruction and an obstructed runner advances beyond the base which, in the umpire’s judgment, the runner would have been awarded because of being obstructed, the runner does so at his/her own risk and may be tagged out. This is a judgment call.) (**NOTE 2:** If the defensive player blocks the base (plate) or base line clearly without possession of the ball, obstruction shall be called. The runner is safe and a delayed dead ball shall be called.)

EXAMPLE: - Play: Runner on first takes off with the crack of the bat. Seeing no trouble making third, he/she rounds second when he/she collides with the shortstop who is wandering around aimlessly. Runner continues to third and the ball beats him/her there. What is the call?

Ruling: *When the runner ran into the wandering shortstop signal and verbalize “obstruction”, but allow the play to continue. On the play at third, raise both hands above your head and call “time”. Explain obstruction on the shortstop, runner is “awarded” third base.*

INSTRUCTOR COMMENTS:

→ See other situations and explanations covered under Rule 2.00-Obstruction.

7.07 – (**Baseball: Intermediate (50-70) Division/Junior/Senior League:** If, with a runner on third base and trying to score by means of a squeeze play or steal, the catcher or any other fielder steps on, or in front of home base without possession of the ball, or touches the batter or the bat, the pitcher shall be charged with a balk, the batter shall be awarded first on the interference and the ball is dead.

INSTRUCTOR COMMENTS:

→ This rule does not apply to Little League Majors and below.

→ Realistically, we know that it’s impossible to enforce both a balk and catcher’s interference on the same play. One had to occur before the other.

→ When the phrase is used, “the pitcher shall be charged with a balk”, that enforcement is simply a scorekeeping matter and results in the run being earned, instead of unearned.

7.08 – Any runner is out when -

- (a) (1) Running more than three feet away from his/her baseline to avoid being tagged, unless such action is to avoid interference with a fielder fielding a batted ball. A runner’s baseline is established when the tag attempt occurs and is a straight line from the runner to the base which he/she is attempting to reach; or

EXAMPLE: - Comment: When a play is being made on a runner, he/she establishes his/her base line as a straight line between his/her position and the base towards which he/she is moving.

INSTRUCTOR COMMENTS:

→ Be aware that the base runner makes his/her own baseline as he/she progresses (or regresses) around the bases. Depending on the circumstances, his/her baseline frequently may change as the play develops.

- (2) after touching first base the runner leaves the baseline, obviously abandoning all effort to touch the next base; or

INSTRUCTOR COMMENTS:

- Any runner after reaching first base who leaves the baseline heading for his/her dugout or his/her position believing that there is no further play, may be declared out if the umpire judges the act of the runner to be considered abandoning his/her efforts to run the bases. Even though an out is called, the ball remains in play in regard to any other runner. **PLAY:** Runner believing he/she is called out on a tag at first or third base starts for the dugout and progresses a reasonable distance still indicating by his/her actions that he/she is out, shall be declared out for abandoning the bases.
- When to call him/her out? Whenever he/she obviously “gives up” and heads towards his/her dugout or, at the end of an inning, towards his/her defensive position. But wait until the runner is on foul ground or well onto the outfield grass before you declare an out.

- (3) the runner does not slide or attempt to get around a fielder who has the ball and is waiting to make the tag; or

Baseball A.R.—There is no “must slide rule.”

EXAMPLE: - Comment: There is “no” must slide rule. The rule is slide or attempt to get around. The key in this situation is “fielder has the ball and is waiting to make the tag.”

INSTRUCTOR COMMENTS:

- Hurdling or going over the defensive player that has the ball and is waiting to make a tag is a legal maneuver. Rule 7.08(a) (3) does not prevent or make hurdling illegal.
- **Rule 7.08(a-3)** is easily the most misunderstood rule in the book. It is easily broken down as follows:
 - (1) The fielder must have the ball in his/her possession; **AND**
 - (2) The fielder must be **WAITING** to make the tag;

If **BOTH** of those two criteria are satisfied, then the runner must **EITHER**:

 - (1) **Slide**; OR
 - (2) **ATTEMPT** to get around the fielder.
- Notice that the rule says, “attempt to get around”, not “avoid”. Contact may occur with no penalty assessed.
- There is no “Must Slide” rule and no league may create one. No league may modify **Rule 7.08(a-3)**.

- (4) (**Tee Ball, Little League (Minor/Major Divisions only)**): the runner slides head first while advancing

INSTRUCTOR COMMENTS:

- This rule does not apply when a runner is returning to a base, only when advancing to a base. Any runner who does a headfirst slide is out at the moment the umpire sees the runner go into the headfirst slide. The ball remains alive and in play and runners may advance at their own risk and plays may be attempted on any other runners. If the runner who is called out for sliding headfirst has been forced to advance by the batter-runner this will be a force out and no runs will score if this is the third out of the inning. In all other instances the headfirst slide will be a timing play when there are two outs.

- (5) (a) **Softball: Major/Junior/Senior League Divisions:** the runner fails to keep contact with the base to which that runner is entitled until the ball has been released by the pitcher on the delivery. **NOTE:** Major Division: A local league may adopt a rule that requires the runner to keep in contact with the base to which that runner is entitled until the ball has been batted or reaches the batter, or be called out.
- (b) **Softball: Minor League/Tee Ball:** the runner fails to keep in contact with the base which that runner is entitled until the ball has been batted or reaches the batter.

NOTE 1: If the ball slips from the pitcher’s hand before, during, or up to the delivery of a pitch, the ball will remain in play and the runner(s) may advance at their own risk (see 8.07(a) Dropped Ball). When a runner is off a base after a pitch or as a result of a batter completing a turn at bat, and while the pitcher has the ball within the eight (8) foot radius circle, the runner must immediately attempt to advance to the next base or return to the base the runner is entitled to.

NOTE 2: If the pitcher has possession of the ball within the pitcher’s circle, and is not making a play (a fake throw is considered a play), runners not in contact with their bases must immediately attempt to advance or return to base.

PENALTY: The ball is dead. “No Pitch” is declared and the runner is out. Eight (8) foot radius circle must be properly marked

Softball: A.R.—After making a decision, should the runner stop again without a play being made before reaching the base, he/she shall be called out. The responsibility for the runners to advance or return is removed if the pitcher attempts a play on a runner.

- (b) intentionally interferes with a thrown ball; or hinders a fielder attempting to make a play on a batted ball; (**NOTE:** A runner who is adjudged to have hindered a fielder who is attempting to make a play on a batted ball is out whether it was intentional or not);

INSTRUCTOR COMMENTS:

- A runner who is adjudged to have hindered a fielder who is attempting to make a play on a batted ball is out whether it was intentional or not.
- If, however, the runner has contact with a legally occupied base when he/she hinders the fielder, he/she shall not be called out unless, in the umpire's judgment, such hindrance, whether it occurs on fair or foul territory is intentional. If the umpire declares the hindrance intentional, the following penalty shall apply: With less than two out, the umpire shall declare both the runner and batter out. With two out, the umpire shall declare the batter out.
- If, in a run-down between third base and home plate, the following runner has advanced and is standing on third base when the runner in a run-down is called out for offensive interference, the umpire shall send the runner standing on third base back to second base. This same principle applies if there is a run-down between second and third base and following runner has reached second (the reasoning is that no runner shall advance on an interference play. A runner is considered to occupy a base until he/she legally has reached the next base).
- A runner need not get off his/her base on a ball that is popped in the air and coming down around his/her base. He/she may stay in contact with the base and show the umpire he/she is trying to avoid the fielder and if there is contact, the ball is alive and in play
- Once again, the base runner has the right of way to the baseline on a thrown ball and can only be called out if he/she INTENTIONALLY interferes with a thrown ball. On a batted ball, however, any interference, whether intentional or otherwise, must be enforced. This could be visual or verbal as well.

- (c) that runner is tagged, when the ball is alive, while off a base;

EXCEPTION: A batter-runner cannot be tagged out after overrunning or over sliding first base if said runner returns immediately to the base.

INSTRUCTOR COMMENTS:

- This includes an award of first base on a base on balls when the runner touches first base and overruns the base.

A.R. 1—This includes a batter-runner who over runs first after being issued a base on balls.

A.R. 2—If the impact of a runner breaks a base loose from its position, no play can be made on that runner at that base if the runner had reached the base safely.

INSTRUCTOR COMMENTS:

- This provision applies if the runner reaches the base safely and does not attempt to advance further

A.R. 3—If a base is dislodged from its position during a play, any following runner on the same play shall be considered as touching or occupying the base if, in the umpire's judgment, that runner touches or occupies the dislodged bag, or the point marked by the original location of the dislodged bag.

INSTRUCTOR COMMENTS:

- The "point marked by the dislodged base" is where the base belongs, not where the base finally rests.

- (d) Failing to retouch the base after a fair or foul fly is legally caught before that runner or the base is tagged by a fielder. The runner shall not be called out for failure to retouch the base after the first following pitch, or any play or attempted play. This is an appeal play.

NOTE: Base runners can legally retouch their base once a fair ball is touched in flight and advance at their own risk if a fair or foul ball is caught.

INSTRUCTOR COMMENTS:

- Runners need not "tag up" on a foul tip. They may steal on a foul tip. If a so-called tip is not caught, it becomes an ordinary foul. Runners then return to their bases.

- (e) Failing to reach the next base before a fielder tags said runner or the base after that runner has been forced to advance by reason of the batter becoming a runner. However, if a following runner is put out on a force play, the force is removed and the runner must be tagged to be put out. The force is removed as soon as the runner touches the base to which that runner is forced to advance, and if over sliding or overrunning the base, the runner must be tagged to be put out. However, if the forced runner, after touching the next base, retreats for any reason towards the base last occupied, the force play is reinstated and the runner can again be put out if the defense tags the base to which the runner is forced;

INSTRUCTOR COMMENTS:

- Runner on first and three balls on batter: Runner steals on the next pitch, which is fourth ball, but after having touched second he/she over slides or overruns that base. Catchers throw catches him/her before he/she can return. **Ruling:** Runner is out. (Force out is removed).
- Over sliding and overrunning situations arise at bases other than first base. For instance, before two are out, and runners on first and second, or first, second and third, the ball is hit to an infielder who tries for the double play. The runner on first beats the throw to second base but over slides the base. The relay is made to first base and the batter-runner is out. The first baseman, seeing the runner at second base off the bag, makes the return throw to second and the runner is tagged off the base. Meanwhile runners have crossed the plate. The question is: Is this a force play? Do the runs that crossed the plate during this play and before the third out was made when the runner was tagged at second, count? Answer: The runs score. It is not a force play. It is a tag play.

- (f) Touched by a fair ball in fair territory before the ball has touched or passed an infielder. The ball is dead and no runner may score, no runners advance, except runners forced to advance;

EXCEPTION: If a runner is touching a base when touched by an Infield Fly, that runner is not out, although the batter is out.

NOTE 1: If a runner is touched by an Infield Fly when not touching a base, both the runner and batter are out.

NOTE 2: If two runners are touched by the same fair ball, only the first one is out because the ball is instantly dead

INSTRUCTOR COMMENTS:

Rule of Thumb: Call the runner out if the ball has not passed or touched an infielder.

- ➔ If the base runner is hit by a fair-batted ball while standing on the base, the runner is out, unless the ball has already passed an infielder OR it's a declared Infield Fly. The base is not a sanctuary.

- (g) Attempting to score on a play in which the batter interferes with the play at home base before two are out. With two out, the interference puts the batter out and no score counts;

INSTRUCTOR COMMENTS:

- ➔ The theory behind this rule is that you penalize what will hurt the offending team (offense) more; less than two out, runner is called out, but with two out, the batter is out and the runner won't score. This way the batter called out won't "leadoff" the following inning.

- (h) passes a preceding runner before such runner is out;

EXAMPLE: One runner may assist another runner in the base line providing the assisting runner is not out or has not passed the runner being assisted! **Play:** Runner on first. Batter hits the ball in between the outfielders. Runner on first falls down on his/her way to second. Batter-runner picks up the runner and sets him/her down on second and returns to first. **Ruling:** Legal play as long as batter-runner does not pass runner.

- (i) After acquiring legal possession of a base, the runner runs the bases in reverse order for the purpose of confusing the defense or making a travesty of the game. The umpire shall immediately call "Time" and declare the runner out;

INSTRUCTOR COMMENTS:

- ➔ This rule limitation does not prevent a runner from returning to a base, such as in a rundown, or a play in which the batter was retired on a fly ball.
- ➔ The batter is not forced to run to first base on a batted ball. He/she may return as far as home plate if he/she desires. At that point, however, the umpire will call him/her out.

- (j) Failing to return at once to first base after overrunning or over-sliding that base. If attempting to run to second the runner is out when tagged. If after overrunning or over-sliding first base, the runner starts toward the dugout, or toward a position, and fails to return to first base at once, that runner is out on appeal, when said runner or the base is tagged.

INSTRUCTOR COMMENTS:

- ➔ A runner may turn in any direction after reaching first base even on a base on balls. Establish the runner's intent to determine if he/she may be put out before returning to first. If an out call is appropriate, the runner must be tagged.
- ➔ "Attempting to run to second" can mean as little as a step in that direction. The intent of the runner, even momentarily, determines whether or not the runner is in jeopardy of being tagged out.
- ➔ If, after overrunning first base, the runner turns to the right, well into foul territory, and notices that the ball was overthrown. Even though the runner is clearly in foul territory, if he/she makes any move as if to run to second, he/she is in jeopardy of being tagged out.

- (k) In running or sliding for home base, the runner fails to touch home base and makes no attempt to return to the base, when a fielder holds the ball in hand, while touching home base, and appeals to the umpire for the decision. (NOTE: This rule applies only where the runner is on the way to the bench and a fielder would be required to chase the runner to tag him/her. It does not apply to the ordinary play where the runner misses the plate and then immediately makes an effort to touch the plate before being tagged. In that case, the runner must be tagged.

INSTRUCTOR COMMENTS:

- ➔ If the runner misses home plate and immediately returns, he/she must be tagged to be out.
- ➔ In the event the runner is attempting to return to touch home plate, keep in mind, even though a baseline doesn't formally exist past home plate, the umpire should recognize a "three-feet either way, directly back to home plate" restriction.

7.09 - It is interference by a batter or a runner when -

- (a) the batter hinders the catcher in an attempt to field the ball;
- (b) the batter intentionally deflects the course of a foul ball in any manner;
- (c) before two are out and a runner on third base, the batter hinders a fielder in making a play at home base; the runner is out;

INSTRUCTOR COMMENTS:

- ➔ With two out, the batter would be called out, the run will not score and the batter will not leadoff the next inning

- (d) Any member or members of the offensive team stand or gather around any base to which a runner is advancing, to confuse, hinder or add to the difficulty of the fielders. Such runner shall be declared out for the interference of teammate or teammates;
- (e) Any batter or runner who has just been put out hinders or impedes any following play being made on a runner. Such runner shall be declared out for interference by a teammate;

INSTRUCTOR COMMENTS:

- ➔ When a runner is moving toward second base on a double play ball, there is no requirement for the runner to slide. The fielder must expect the runner to be there. As long as the runner is moving toward the base, there would generally be no interference.
- ➔ If sliding into second base, the runner must be able to reach the base with hand or feet. If the sliding runner is not able to reach the base with his/her hand or feet, and in the umpire's judgment the slide caused the second baseman not to complete the double play, call interference and get the out at first base also.
- ➔ If the batter or a runner continues to advance after he/she has been put out, he/she shall not by that act alone be considered as confusing, hindering or impeding the fielders.
- ➔ If contact between the runner and fielder occurs after the ball is released, there would be no interference.

- (f) If, in the judgment of the umpire, a base runner willfully and deliberately interferes with a batted ball or a fielder in the act of fielding a batted ball with the obvious intent to break up a double play, the ball is dead. The umpire shall call the runner out for interference and also call out the batter-runner because of the action of the runner. In no event may bases be run or runs scored because of such action by a runner

EXAMPLE: Play: Runners on first and third, no outs. Ball grounded towards second. The runner on third going home. The runner on first stops momentarily in front of the second baseman causing him/her to miss the ball. **Ruling:** This is intentional interference. The runner from first AND the batter-runner are called out. The runner from third is returned to third.

- (g) if, in the judgment of the umpire, a batter-runner willfully and deliberately interferes with a batted ball or a fielder in the act of fielding a batted ball, with the obvious intent to break up a double play, the ball is dead. The umpire shall call the batter-runner out for interference and shall also call out the runner who advanced closest to the home plate regardless of where the double play might have been possible. In no event shall bases be run because of such interference;

EXAMPLE: Play: Runners on first and third, no outs. Batter bunts the ball down the first base line with the runners advancing. The pitcher is about to field the ball for a play at second and the batter-runner intentionally runs into him/her. **Ruling:** The batter-runner and runner on third are called out. The runner from first is returned to first

INSTRUCTOR COMMENTS:

- ➔ Notice the difference between 7.09(f) and 7.09(g). While both situations involve willful and deliberate actions, one is committed by a base runner; the other is committed by the batter-runner. This changes the penalty

- (h) in the judgment of the umpire, the base coach at third base, or first base, by touching or holding the runner, physically assists that runner in returning to or leaving third base or first base;

A.R.—When a play is being made on the assisted runner, the runner is out and all runners return to the bases occupied at the time of the interference (dead ball). If no play is being made on the assisted runner, the runner is out and play continues (delayed dead ball)..

EXAMPLE: Play: Runner on third, one out, fly ball hit to deep left. Runner on third stays on the bag waiting for the third base coach to signal when the catch is made. The coach slaps the runner on the back when the ball is caught; he/she runs home and scores. **Ruling:** WRONG! Runner declared out because the third base coach touching him/her was illegal assistance.

Play: The runner trips over the base rounding third. The coach helps him/her up and pushes the runner back to third or sends him/her home. **Ruling:** Runner is out because of the coach's assistance. **Play:** The batter hits a home run with the bases full. Each runner who passes the third base coach is congratulated with a "high five" by the base coach. **Ruling:** No call. This is not assistance.

Comment: When a play is being made on the assisted runner, the umpire shall call "Time" and enforce the penalty: The runner is out and all runners return to the bases occupied at the time of the interference. If no play is being made on the assisted runner, the umpire shall signal that the runner is out and allow plays on other runners if possible (delayed dead ball).

INSTRUCTOR COMMENTS:

- ➔ Giving a "high five" or patting the player on the back after a home run IS NOT PHYSICAL ASSISTANCE. Do not call the player out for receiving a "high five" or a congratulatory pat on the back in situations such as this.
- ➔ **Physically assisting** implies that the coach did something by touching the runner which improved that runner's chance of accomplishing his/her goal as a runner. In other words, touching alone does not constitute **physically assisting**, the umpire must be convinced that the runner is trying to get back to a base or is trying to advance with a sense of urgency.
- ➔ When a play is being made on the **assisted** runner, the umpire should call "Time" and enforce the penalty: The runner is out and all runners return to the bases occupied at the time of the interference (assistance). If no play is being made on the assisted runner, the umpire shall signal that the runner is out and allow plays on other runners if possible (delayed dead ball).

- (j) with a runner on third base, the base coach leaves the box and acts in any manner to draw a throw by a fielder;

EXAMPLE: Play: Runner on third, one out, fly ball to right field. Third base coach dashes down the line toward home and draws a throw that gets by the catcher, allowing the runner on third to score. **Ruling:** *Call the runner out for interference by third base coach*

- (k) the runner fails to avoid a fielder who is attempting to field a batted ball, or intentionally interferes with a thrown ball, provided that if two or more fielders attempt to field a batted ball and the runner comes in contact with one or more of them, the umpire shall determine which fielder is entitled to the benefit of this rule, and shall not declare the runner out for coming in contact with a fielder other than the one the umpire determines to be entitled to field such ball

INSTRUCTOR COMMENTS:

➔ This further demonstrates that the right of way to the baseline belongs to the fielder on a batted ball and to the base runner on a thrown ball.

- (l) a fair ball touches the batter or runner in fair territory before touching a fielder. If a fair ball goes through or by an infielder and touches a runner immediately back of said infielder or touches the runner after having been deflected by a fielder, the umpire shall not declare the runner out for being touched by a batted ball. In making such decision, the umpire must be convinced that the ball passed through or by the infielder and that no other infielder had a chance to make a play on the ball. If in the judgment of the umpire, the runner deliberately and intentionally kicks such a batted ball on which the infielder had missed a play, then the runner shall be called out for interference.

INSTRUCTOR COMMENTS:

If a batted ball goes past an infielder and hits a runner, the umpire must determine if another infielder had a chance to make a play.

Example: Runner on second base. The batter smacks a ground ball between third base and shortstop. The ball gets by the third baseman diving to his/her left and hits the runner advancing to third. In your judgment the shortstop had a good chance of fielding the ball and retiring the batter-runner but the ball hit the runner. Rule the runner out for interference and award the batter runner 1st base

PENALTY FOR INTERFERENCE: The runner is out and the ball is dead.

7.10 - Any runner shall be called out on appeal if -

- (a) After a fly ball is caught the runner fails to retouch the base before said runner or the base is tagged; (NOTE: "Retouch" in this rule means to tag up and start from a contact with the base after the ball is caught. A runner is not permitted to take a flying start from a position in back of, and not touching, the base);

INSTRUCTOR COMMENTS:

➔ This is an example when an appeal does not have to be made verbally. When a runner is returning to a base on a caught fly ball, if the ball arrives before the runner does, the umpire will call the runner out

- (b) with the ball in play, while advancing or returning to a base, the runner fails to touch each base in order before said runner, or a missed base, is tagged;

A.R.—(1) No runner may return to touch a missed base after a following runner has scored. (2) When the ball is dead, no runner may return to touch a missed base or one abandoned after said runner has advanced to and touched a base beyond the missed base.

Play A – Batter hits the ball out of the park, or hits a ground rule double, and misses first base (ball is dead). The runner may return to first base to correct the mistake before touching second. But if the runner touches second, he/she may not return to first and if the defensive team appeals, the runner is declared out at first. (**Appeal play.**)

Play B – Batter hits a ground ball to shortstop, who throws wild into the stands (ball is dead). Batter-runner misses first base but is awarded second base on the overthrow. Even though the umpire has awarded the runner second base on the overthrow, the runner must touch first base before proceeding to second base. (**Appeal play.**)

EXAMPLE: Play: Runners on second and third. Batter hits a triple. Runner from third misses home plate, runner from second tags home plate. Now runner from third returns and touches home plate. **Ruling:** Too late! Does not change a thing. Runner from third is still in jeopardy of being called out on an appeal

INSTRUCTOR COMMENTS:

➔ A common play that confuses many is when a throw is made to first base to retire a batter-runner that misses first. If the ball arrives after the batter-runner has missed first and advanced past first, signal the runner "Safe". This is now an appeal play, since the runner is considered as having touched a base when they move past a base until such time he/she is appealed

- (c) the runner overruns or over-slides first base and fails to return to the base immediately, and said runner or the base is tagged;
- (d) the runner fails to touch home base and makes no attempt to return to that base, and home base is tagged; **NOTE:** A runner forfeits his/her opportunity to return to home base when he/she enters the dugout or any other dead ball area.

Any appeal under this rule must be made before the next pitch, or any play or attempted play. No appeal can be made if the ball is dead. If the violation occurs during a play which ends a half-inning, the appeal must be made before all the defensive players have left fair territory on their way to the bench or dugout.

EXCEPTION: If an otherwise proper appeal is being made by a player who has to go into foul territory to retrieve the ball in order to make an appeal or if the appeal is being made by catcher (who may have never been in fair territory at all), the appeal will be adjudged to have been properly executed.

INSTRUCTOR COMMENTS:

- The defensive team is considered to have left the field when no players remain in fair territory, with the exception of the catcher and a player who is retrieving a ball in foul territory in an attempt to make an appeal

An appeal is not to be interpreted as a play or an attempted play

INSTRUCTOR COMMENTS:

- In **Softball**, a fake throw by the pitcher, from within the eight-foot circle is considered an attempted play for the interpretation of the circle rule. See 7.08(4). Any other fielder in **Softball** making a fake throw is **NOT** considered as having made an attempted play. A fake throw is **NOT** an attempted play in **Baseball**.
- This is only to enable the defense to execute more than one appeal. If an appeal were considered a play or an attempted play, then no further appeals could be allowed.
- In **Baseball**, an appeal may be made directly from the pitcher's plate. If, however, the pitcher decides to disengage the pitcher's plate, he/she must do so with the pivot foot first; otherwise, it will be a balk or illegal pitch. With no runners on base, it makes no difference, since the pitcher cannot balk without runners on base.
- In **Softball** when making an appeal, the pitcher shall not throw to a base while the foot is in contact with the pitcher's plate. In putting the ball back into play, after taking the pitching position, the pitcher shall step backwards off the pitcher's plate (with the pivot foot first) to begin the appeal. Penalty: Call an illegal pitch and award a ball to the batter's count.

Softball: In making an appeal, the pitcher shall not throw to a base while the foot is in contact with the pitcher's plate. In putting the ball back into play, after taking the pitching position, the pitcher shall step backwards off the pitcher's plate (with the pivot foot first) to begin the appeal. **PENALTY:** Illegal pitch 8.05(e)

Successive appeals may not be made on a runner at the same base. If the defensive team on its first appeal errs, a request for a second appeal on the same runner at the same base shall not be allowed by the umpire. (Intended meaning of the word "err" is that the defensive team in making an appeal threw the ball out of play. For example, if the pitcher threw to first base to appeal and threw the ball into the stands, no second appeal would be allowed.)

INSTRUCTOR COMMENTS:

- Anytime the defensive team, in making an appeal, causes the ball to become dead with runners advancing (balk, throw out of play, etc.), no second appeal will be allowed on any runner. Such act would now be considered an attempted play, and thus would nullify further appeals

NOTE 1: Appeal plays may require an umpire to recognize an apparent "fourth out." If the third out is made during a play in which an appeal play is sustained on another runner, the appeal play decision takes precedence in determining the out. If there is more than one appeal during a play that ends a half-inning, the defense may elect to take the out that gives it the advantage. For the purposes of this rule, the defensive team has "left the field" when all players have left fair territory on their way to the bench or dugout. (**SOFTBALL EXCEPTION:**) If an otherwise proper appeal is being made by a player who has to go into foul territory to retrieve the ball in order to make an appeal or if the appeal is being made by the catcher (who may never have been in fair territory at all), the appeal will be adjudged to have been properly executed.

BASEBALL NOTE 2: If a pitcher commits an illegal pitch (a balk in **Intermediate (50/70) Division/Junior/Senior League Baseball**) when making an appeal, such act shall be a play. An appeal should be clearly intended as an appeal, either by a verbal request by the player or an act that unmistakably indicates an appeal to the umpire. A player, inadvertently stepping on the base with a ball in hand, would not constitute an appeal. The ball must be alive and in play.

SOFTBALL NOTE 2: An appeal should be clearly intended as an appeal, either by a verbal request by the player or an act that unmistakably indicates an appeal to the umpire. A player, inadvertently stepping on the base with a ball in hand, would not constitute an appeal. The ball must be live to make an appeal.

EXAMPLE: Play: Runners on first and third, two outs. The batter singles to left field. The runner on third scores and runner on first is thrown out trying to reach third, missing second on his/her way, for the third out. The defensive team is leaving the field when the defensive coach yells at the right fielder, the last player in fair territory, to pick up the ball, step on second, appeal the runner missing second. **Ruling:** The runner is out on a force at second. The fourth out takes precedence over the third out and the run scored is nullified.

EXAMPLE: How to make a proper appeal: To make an appeal, first you (the umpire) must make sure the ball is live. If the ball is live, it does NOT have to go back to the pitcher. The ball may be taken straight to the base missed, or to the runner who missed the base or who left early. The base or the runner can be tagged. The defense then tells the umpire what they are doing. Example: "Mr. Umpire, the runner who was on second left before the catch." The umpire then declares the runner either safe or out. If the umpire has a dead ball situation, in other words, "time" has been called or the ball has gone into a dead ball area, he/she must first make a live ball situation. How do the umpires make a ball live after it was dead? CPR! No. I refer you to Rule 5.11. Get a ball to the pitcher, get him/her to toe the pitcher's plate (stand on it), and you, the umpire, yell "play" or "play ball". Now the ball is alive. Now follow the procedure outlined above for a live ball appeal.

INSTRUCTOR COMMENTS:

- If a pitcher balks when making an appeal, the balk is considered a play. An appeal should be clearly intended as an appeal, either by a verbal request by the player or an act that unmistakably indicates an appeal to the umpire. A player, inadvertently stepping on the base with a ball in his/her hand, would not constitute an appeal. Time is not out when an appeal is being made.

7.11 - The players, coaches or any member of an offensive team shall vacate any space (including both dugouts) needed by a fielder who is attempting to field a batted or thrown ball

PENALTY: Interference shall be called and the batter or runner on whom the play is being made shall be declared out.

INSTRUCTOR COMMENTS:

- Obviously, since in Little League programs, the dugouts are out of play, the fielder may not go into a dugout to make a play. However, if someone inside the dugout interferes with the player when he/she reaches into the dugout, interference shall be called. Depending on the team at fault, this could result in an out call, awarding bases, or nullifying the outcome.

7.12 - Unless two are out, the status of a following runner is not affected by a preceding runner's failure to touch or retouch a base. If, upon appeal, the preceding runner is the third out, no runners following the preceding runner shall score. If such a third out is the result of a force play, neither the preceding nor following runners shall score.

7.13 – When a pitcher is in...

Baseball - Little League (Major) and Minor League: contact with the pitcher's plate and in possession of the ball and the catcher is in the catcher's box ready to receive delivery of the ball, base runners shall not leave their bases until the ball has been delivered and has reached the batter. **NOTE: Tee Ball:** Base runners must stay in contact with the base until the ball is hit. When players have advanced as far as possible without being put out or having been retired, the umpire shall call "time" and place the ball on the tee.

INSTRUCTOR COMMENTS:

- In Minor League and Tee Ball, the local leagues may adopt the option that a base runner is called out for leaving the base before the pitched ball has reached the batter.
- If, in the umpire's judgment, the manager is instructing his/her players to leave early intentionally, the manager may be warned and/or ejected from the game for deliberately violating the rules.
- When a runner is legitimately off his/her base, the pitcher cannot stop the runner by taking the ball back to the pitcher's plate.
- The catcher is "ready to receive delivery" of the pitch when he/she has his/her mask on and is facing the pitcher. It is not necessary for him/her to be in a squat position.
- Until the pitcher and catcher have satisfied the above elements of this rule, the runners are free to advance without violation.

The violation by one base runner shall affect all other base runners -

- (a) when a base runner leaves the base before the pitched ball has reached the batter and the batter does not hit the ball, the runner is permitted to continue. If a play is made on the runner and the runner is out, the out stands. If said runner reaches safely the base to which the runner is advancing, that runner must be returned to the base occupied before the pitch was made, and no out results;

INSTRUCTOR COMMENTS:

- It doesn't matter which runner leaves early. The violation affects each and every base runner.
- Rule 7.13(a) will be enforced after all play has stopped. If the batter does not hit the ball, umpires will allow the play to continue until all play has been completed. Any outs on the play will stand. All other runner(s) will return to their original base or bases.

[CHALLENGER: Base stealing is not permitted. Base runners shall not leave their bases until the ball is batted. Violation: All base runners are returned to their original bases and "no pitch" declared.]

- (b) when a base runner leaves the base before the pitched ball has reached the batter and the batter hits the ball, the base runner or runners are permitted to continue. If a play is made and the runner or runners are put out, the out or outs will stand. If not put out, the runner or runners must return to the original base or bases or to the unoccupied base nearest the one that was left; In no event shall the batter advance beyond first base on a single or error, second base on a double or third base on a triple. The Umpire-in-Chief shall determine the base value of the hit ball

EXAMPLE: Play: Bases loaded and any one of the runners leaves his/her base early, batter hits a clean triple, but is thrown out at the plate trying to score after the over throw at third. Ruling: "Time" is called, the out stands. Return all runners to first, second and third

INSTRUCTOR COMMENTS:

- Note that the umpire determines the base value of the hit ball, not the scorekeeper. This is not protestable, but rather the judgment of the umpire.
- The batter may not advance beyond first base on a single or an error, including two-base errors, obstruction or any other award he/she may receive. This also applies to a batter-runner who advances to first base on uncaught/dropped third strike,, he/she will not be allowed advance any further than first base, even on an over throw.
- If at the end of the entire play, an open base exists, the runners must return to the original base or to the one nearest to the one that was left early.

- (c) when any base runner leaves the base before the pitched ball has reached the batter and the batter bunts, hits a ball within the infield or advances on an uncaught third strike, no run shall be allowed to score. If three runners were on the bases and the batter reaches first base safely, each runner shall advance to the base beyond the one they occupied at the start of the play except the runner who occupied third base, that runner shall be removed from the base without a run being scored.

NOTE: See exceptions following this rule.

EXCEPTION: If at the conclusion of the play there is an open base, paragraphs (a) and (b) will apply.

EXAMPLE: Play: Bases loaded and any one of the runners leaves his/her base early. Ball hit to shortstop that goes through his/her legs onto the outfield grass. Ruling: All runners advance safely. One run will score because the ball was not valued as an infield hit. Remember, the ball must stay in the infield to use 7.13(c).

INSTRUCTOR COMMENTS:

- Logic behind 7.13(c) is as follows: If the ball makes it to the outfield, all runners would normally be expected to advance one base safely, so in a bases loaded situation, one run would score. In the same bases loaded situation, however, if the ball stayed within the infield, even on an uncaught/dropped third strike, a runner leaving early may have prevented the defense from executing a force play at one of the bases, so no run will score. On an uncaught third strike if the pitch goes into dead ball territory the run will then count as the ball did not stay within the infield.
- If a runner is removed by enforcing this rule, instruct the scorekeeper to write 7.13(c) (the rule reference) with a large "X" through the box. No run is scored and no out is recorded. The runner just goes back to the dugout.

EXAMPLES:

1. Runner on first leaves too soon, batter reaches first safely, runner goes to second.
2. Runner on second leaves too soon, batter reaches first safely, runner returns to second.
3. Runner on third leaves too soon, batter reaches first safely, runner returns to third.
4. Runner on first leaves too soon, batter hits clean double, runner goes to third only.
5. Runner on second leaves too soon, batter hits clean double, runner goes to third only.
6. Runner on third leaves too soon, batter hits clean double, runner returns to third.
7. All runners on base will be allowed to score when the batter hits a clean triple or home run, regardless of whether any runner left too soon.
8. Runners on first and second, either leaves too soon, batter reaches first safely, runners go to second and third.
9. Runners on first and second, either leaves too soon, batter hits clean double, runner on first goes to third, runner on second scores.
10. Runners on first and third, either leaves too soon, batter reaches first safely, runner on first goes to second, runner on third remains there.
11. Runners on first and third, either leaves too soon, batter hits a clean double, runner on first goes to third, runner on third scores.
12. Runners on second and third, either leaves too soon, batter reaches first safely, neither runner can advance.
13. Runners on second and third, either leaves too soon, batter hits a clean double, runner on third scores, runner on second goes to third.
14. Runners on first, second and third, any runner leaves too soon, batter hits clean double, runners on second, third score, runner on first goes to third.
15. Bases full, any runner leaves too soon, batter reaches first safely on any ball bunted or hit within the infield, all runners advance one base except runner advancing from third. Runner advancing from third is removed, no run is scored and no out charged. If on the play, a putout at any base results in an open base, runner who occupied third base returns to third base.
16. Bases full, any runner leaves too soon, batter received a base on balls or is hit by a pitch, each runner will advance one base and a run will score.

NOTE 1: When an umpire detects a base runner leaving the base too soon, that umpire shall drop a signal flag or handkerchief immediately to indicate the violation.

INSTRUCTOR COMMENTS:

- The note indicates “drop a signal flag” to indicate the violation. This shall be done immediately. Do not trust this to memory. It’s tough to sell that a runner left early, if there was no visible verification.

NOTE 2: For purpose of these examples, it is assumed that the batter-runner remains at the base last acquired safely.

INSTRUCTOR COMMENTS:

- If the batter-runner or any other base runner is put out on a play in which a runner left early, it may result in open base(s), in which case, runners will return.

NOTE 3: Tee Ball: Base runners must stay in contact with the base until the ball is hit. When players have advanced as far as possible without being put out or having been retired the umpire shall call “time” and place the ball on the tee.

7.13 – When a pitcher is in... **Softball - Majors/Junior/Senior League:** the eight (8) foot radius circle and in possession of the ball, the base runner(s) shall not leave their base(s) until the pitched ball has been released by the pitcher. See Rule 7.08(a) for penalty.

Applies to all divisions of Softball - EXAMPLE: - Note: If the pitcher has possession of the ball within the pitcher’s circle, and is not making a play (a fake throw by the pitcher is considered a play), runners not in contact with their bases must immediately attempt to advance or return to base.

Comment: (1) Don’t guess her out! Make sure she left early or was off the base when the ball is in the circle. (2) The defense cannot freeze runners merely by getting the ball in the circle. Any runner(s) advancing or returning to base may do so without penalty.

Play: With a runner on second, the batter takes a called third strike for the first out of the inning; meanwhile, the runner on second leads off after the catcher received the pitch. Catcher returns ball to the pitcher who has it within the eight (8) foot radius of the pitcher’s plate. The runner at this moment makes no attempt to move either way.

Ruling: The runner must immediately return to second or immediately advance to the next base. Failure to immediately return to her base or proceed to the next base once the pitcher has the ball within the eight (8) foot radius of the pitcher’s plate will result in the base-runner being declared out.

EXAMPLE: Note: While only one runner can be declared out for a single violation of the rule, this important point should be followed: If several runners violate, declare out the most advanced runner. The one closest to home.

INSTRUCTOR COMMENTS:

- For added clarification, please see comments after (Softball) Rule 7.08(a-5).

NOTE 1: Minor League: When the pitcher is in the eight (8) foot radius circle and in possession of the ball, the base runner(s) shall not leave their base(s) until the pitched ball has been batted or reaches the batter. See Rule 7.08(a) for penalty. Local leagues may adopt this rule for their Major Division.

NOTE 2: Tee Ball: Base runners must stay in contact with the base until the ball is hit. When players have advanced as far as possible without being put out or having been retired the umpire shall call “time” and place the ball on the tee.

7.14 - Once each inning a team may utilize a player who is not in the batting order as a special pinch-runner for any offensive player. A player may only be removed for a special pinch runner one time during a game. The player for whom the pinch runner runs is not subject to removal from the lineup. If the pinch runner remains in the game as a substitute defensive or offensive player, the player may not be used again as a pinch-runner while in the batting order. However, if removed for another substitute that player or any player not in the lineup, is again eligible to be used as a pinch runner. A local league may adopt Tournament Rule 3(e) for 7.14. **NOTE: Does not apply if the local league adopts the continuous batting order. See Rule 4.04.**

EXAMPLE: Play: Bottom of the 7th inning, no outs and tie score, Billy strokes a single; however, he is also the team's slowest runner. In an attempt to get speed in the game, the manager wants to use Jane as a "special pinch-runner." Jane had been in the game in innings 3 through 6. Is this legal?

Ruling: Yes. A player who is not in the lineup may be used as a special pinch runner. As long as Jane is not currently in the game (lineup); she is eligible to be pinch runner.

7.15– Procedures for Use of a Double First Base: The double base may be used for first base only. The base must be rectangular, with two sides not less than 14 inches and not more than 15 inches, and the other two sides not less than 28 inches and not more than 30 inches. The longer sides shall face toward home plate and the right field corner. The outer edges shall not be more than two and one-fourth ($2\frac{1}{4}$) inches thick, filled with soft material, and covered with canvas or rubber. Half the base is white (entirely over fair territory) and half is orange or green (entirely over foul territory). When using the double first base, the following rules must be observed:

- (a) A batted ball that hits the white section of the double base shall be declared fair. A batted ball that hits the colored (orange or green) section, without first touching or bounding over the white section, shall be declared foul.
- (b) Whenever a play is being made on the batter-runner, the defense must use the white section of the double first base.

NOTE 1: A play is being made on the batter-runner when he/she is attempting to reach first base while the defense is attempting to retire him/her at that base.

NOTE 2: If there is a play on the batter-runner, and the batter-runner touches only the white portion and the defense appeals prior to the batter-runner returning to first base it is treated the same as missing the base. Penalty: batter-runner is out.

- (c) Whenever a play is being made on the batter-runner, the batter-runner must use the colored (orange or green) section on his/her first attempt to tag first base.

NOTE: On extra-base hits or other balls hit to the outfield when there is no chance for a play to be made at the double first base, the batter-runner may touch either the white or colored (orange or green) section of the base. Should, however, the batter-runner reach and go beyond first base, he/she may only return to the white section of the base. **Penalty:** If there is a play on the batter-runner, and the batter-runner touches only the white portion and the defense appeals prior to the batter-runner returning to first base, it is treated the same as missing the base. If properly appealed, the batter-runner is out.

- (d) When tagging up on a fly ball, the white section of the base must be used by the runner. One foot is permitted to extend behind the base into foul territory, as long as the front foot is touching the white section of the base. **Penalty:** If properly appealed runner is out.
- (e) When leaving base on a pitched ball in ...
 - (Baseball: Little League Majors and below) the runner must maintain contact with the white section of the base until the ball has reached the batter. Runners may extend a foot behind the white portion of the base, but must maintain contact with the white section until the ball has reached the batter. **Penalty (Baseball): See Rule 7.13**
 - (Softball: Little League Majors, Juniors and Senior League), the runner must maintain contact with the white section of the base until the ball has been released by the pitcher on the delivery (Minors: the pitched ball has reached the batter). Runners may extend a foot behind the white portion of the base, but must maintain contact with the white section until the ball has reached the batter. **Penalty (Softball): See Rule 7.08 (a) (5)**
- (f) On an attempted pick-off play, the runner must return to the white section of the base only. This includes a throw from the pitcher, catcher, or any other player, in an attempt to retire the runner at the double first base.
- (g) In **Baseball and Softball: Little League Majors/Baseball :Intermediate (50/70) Division/ Baseball and Softball Junior/Senior League Baseball]** divisions, when the batter becomes a runner on a third strike not caught by the catcher, the batter-runner and the defensive player may use either the colored (orange or green) or the white section.

Softball Only:

1. On any force out attempt from the foul side of first base, or;
 2. On any errant throw pulling the defense off the base into foul territory, or;
 3. When the defensive player used the colored portion of the double base, the batter-runner can run in fair territory when the throw is coming from the foul side of first base, and if hit by the thrown ball, it is not interference. If intentional interference is ruled, the runner is out.
- (h) Use of the double first base does not change any other rule concerning interference or obstruction at first base. (An errant throw into the three-foot running lane could still result in an obstruction call. Also, the batter-runner must still avoid interference with the fielder attempting to field a batted ball.)

8.00 - THE PITCHER (BASEBALL)

8.01 – Legal pitching delivery. There are two legal pitching positions, the Windup Position and the Set Position, and either position may be used at any time. Pitchers shall take signs from the catcher while standing on the pitcher's plate.

Pitchers may disengage the pitcher's plate after taking their signs but may not step quickly onto the pitcher's plate and pitch. This may be judged a quick pitch by the umpire. When the pitcher disengages the pitcher's plate, he/she must drop the hands to the sides

INSTRUCTOR COMMENTS:

- When the pitcher disengages the pitcher's plate, the rule says that he/she must separate and drop his/her hands to the side before stepping back onto the pitcher's plate. The pitcher **DOES NOT** have to immediately separate his/her hands after disengaging the pitcher's plate but he/she **MUST** have separated and dropped his/her hands before reengaging the pitcher's plate. This to prevent the pitcher from stepping onto the pitcher's plate and going right into his/her motion (a possible quick pick situation) and it also allows any base runners to be able to pick up where the ball is located.

[CHALLENGER: Players may pitch. A player, referred to as the pitcher, shall be positioned in the pitching circle during play.]

EXAMPLE: The pitcher may take signs from the manager or coach while on the pitchers plate as long as he/she does not "unnecessarily delay" the game. This is also to prevent the pitcher from throwing a "Quick Pitch" by taking the sign while off the pitchers plate and quickly walking through the pitching motion. If the manager/coach insists on calling pitches, the manager/coach should give the signs to the catcher who relays it to the pitcher while the pitcher is on the pitchers plate.

- (a) **The Windup Position.** The pitcher shall stand facing the batter, the pivot foot in contact with the pitcher's plate, and the other foot free. From this position any natural movement associated with the delivery of the ball to the batter commits the pitcher to pitch without interruption or alteration. The pitcher shall not raise either foot from the ground, except that in the actual delivery of the ball to the batter, said pitcher may take one step backward and one step forward with the free foot.

From this position the pitcher may:

- (1) deliver the ball to the batter, or
- (2) step and throw to a base in an attempt to pick off a runner, or
- (3) disengage the pitcher's plate. In disengaging the pitcher's plate, the pitcher must step off with the pivot foot and not the free foot first. The pitcher may not go into a set or stretch position. If the pitcher does, it is an illegal pitch [a balk in **Intermediate (50/70) Division/Junior/Senior League Baseball**].

NOTE: When a pitcher holds the ball with both hands in front of the body, with the pivot foot in, contact with the pitcher's plate, and the other foot free, that pitcher will be considered in a Windup Position.

INSTRUCTOR COMMENTS:

- This position means that the shoulders should be parallel with a line extending from first base to third base.
- It is legal to step and throw to a base from the windup position. However, once the pitcher begins his/her pitching motion, which can include a step back with the non-pivot foot, he/she is committed to the pitch and may not throw to a base.

- (b) **The Set Position.** Set Position shall be indicated by the pitcher when that pitcher stands facing the batter with the pivot foot in contact with, and the other foot in front of the pitcher's plate, holding the ball in both hands in front of the body and coming to a complete stop. From such set position the pitcher may deliver the ball to the batter, throw to a base or step backward off the pitcher's plate with the pivot foot. Before assuming the Set Position, the pitcher may elect to make any natural preliminary motion such as that known as "the stretch." But if the pitcher so elects, that pitcher shall come to the Set Position before delivering the ball to that batter.

NOTE: In **Little League (Majors)** and below the pitcher need not come to a complete stop. **Intermediate (50/70) Division/Junior/Senior League** the pitcher must come to a complete and discernible stop.

EXAMPLE: In Major Little League (and below), the pitcher may windup from the Set Position.

EXAMPLE: Comment: In Intermediate 50/70, Juniors, Seniors the pitcher, following "the stretch", must hold the ball in both hands in front of his/her body **AND** come to a complete stop, with both feet on the ground. Umpires should watch this closely and should immediately call a "balk" for any violation made with runners on base.

INSTRUCTOR COMMENTS:

- In **Majors** and **Minors**, the pitcher need not come to a complete stop in a set position, since the base runners may not leave their bases until the ball reaches the batter.
- While it is legal in the **Majors** and **Minors** for a pitcher to windup from a set position, it is a delivery that should not be taught. It will be a balk once the pitcher enters the **Intermediate (50/70) Division and above**.

- (c) At any time during the pitcher's preliminary movements and until the natural pitching motion commits that pitcher to the pitch, said pitcher may throw to any base provided the pitcher steps directly toward such base before making the throw. The pitcher shall step "ahead of the throw." A snap throw followed by the step toward the base is an illegal pitch. (A balk in **Intermediate (50/70) Division/Junior/Senior League**) (See Penalty for illegal pitch/balk under Rule 8.05.)

- (d) If the pitcher makes an illegal pitch with the bases unoccupied, it shall be called a ball unless the batter reaches first base on a hit, an error, a base on balls, a hit batter, or otherwise. A ball which slips out of the pitcher's hand and crosses the foul line shall be called a ball; otherwise it will be called "no pitch" without runners on base, and an illegal pitch [a balk in **Intermediate (50-70) Division/Junior/Senior League**] with runners on base. (See Penalty for illegal pitch under Rule 8.05.)
- (e) If the pitcher removes the pivot foot from contact with the pitcher's plate by stepping backward with that foot, that pitcher thereby becomes an infielder and in the case of a wild throw from that position, it shall be considered the same as a wild throw by any other infielder.

INSTRUCTOR COMMENTS:

- The pitcher, while off the pitcher's plate may throw to any base. If he/she makes a wild throw, such throw is the throw of an infielder and what follows is governed by the rules covering a ball thrown by a fielder. See Rule 7.05(g).

- (f) A pitcher must indicate visually to the Umpire-in-Chief, the batter, and any runners the hand with which he/she intends to pitch, which may be done by wearing his/her glove on the other hand while touching the pitcher's plate. The pitcher is not permitted to pitch with the other hand until the batter is retired, the batter becomes a runner, the inning ends, the batter is substituted for by a pinch-hitter, or the pitcher incurs an injury. In the event a pitcher switches pitching hands during an at-bat because he/she has suffered an injury, the pitcher may not, for the remainder of the game, pitch with the hand from which he/ she has switched. The pitcher shall not be given the opportunity to throw any preparatory pitches after switching pitching hands. Any change of pitching hands must be indicated clearly to the Umpire-in-Chief.

INSTRUCTOR COMMENTS:

- This new rule makes it clear that if there is an ambidextrous pitcher that he/she will have to declare which hand he/she is going to pitch to the batter with. This is to keep the batter and pitcher from playing games as to from what side the batter will hit in relationship to which arm the pitcher is going to use to pitch with and trying to keep changing and delaying the game. As written when the pitcher is touching the pitcher's plate the hand without the glove on at that point is the hand he will have to use for that batter. The way the rule is written there is no penalty prescribed so this would be one of those things that the umpire will say "Don't Do That" and if the pitcher keeps disobeying the umpire, then that pitcher could be removed for unsportsman like conduct.

- (g) **Baseball: Tee Ball:** The pitcher shall keep both feet on the pitcher's plate until the ball is hit.

8.02 - The pitcher shall not -

- (a) (1) bring the pitching hand in contact with the mouth or lips while 10-foot circle (18-foot circle in **Intermediate (50-70) Division/Junior/ Senior League**) surrounding the pitcher's plate; **EXCEPTION:** Provided it is agreed to by both managers, the umpire, prior to the start of a game played in cold weather, may permit the pitcher to blow on his/her hands while in the 1¹/₈-foot circle.

PENALTY: For violation of this part of the rule the umpires shall immediately call a ball and warn the pitcher that repeated violation of any part of this rule can cause the pitcher to be removed from the game. However, if the pitch is made and a batter reaches first base on a hit, an error, a hit batter or otherwise, and no runner is put out before advancing at least one base, the play shall proceed without reference to the violation.

INSTRUCTOR COMMENTS:

- Realistically, the pitch, in this circumstance, should never be delivered. The call should be made immediately when the pitcher touches his/her hand to his/her mouth.
- Generally, the plate umpire should make this call, unless the pitcher's back is turned away from the plate.
- If the pitcher commits this violation when "Time" has been called, simply warn the pitcher not to do it again.

- (2) apply a foreign substance of any kind to the ball;
- (3) expectorate on the ball, either hand or the glove;
- (4) rub the ball on the glove, person, or clothing;
- (5) deface the ball in any manner; or
- (6) deliver what is called the "shine" ball, "spit" ball, "mud" ball, or "emery" ball. The pitcher is allowed to rub off the ball between the bare hands;

INSTRUCTOR COMMENTS:

- If a pitcher were wearing a batting glove under his/her fielder's glove, it would be very difficult to rub the ball "between the bare hands." Simply, don't allow the pitcher to wear a batting glove and you avoid the problem.

PENALTY: For violation of any part of Rules 8.02(a)(2) through (6) the umpire shall: Call the pitch a ball and warn the pitcher. If a play occurs on the violation, the manager of the offense may advise the plate umpire of acceptance of the play. (Such election must be made immediately at the end of play.)

INSTRUCTOR COMMENTS:

- As with the elements of **Rule 8.02 (a-1)**, the pitch should never be delivered. Call the violation when it happens.

NOTE: A pitcher may use a rosin bag for the purpose of applying rosin to the bare hand or hands. Neither the pitcher nor any other player shall dust the ball with the rosin bag; neither shall the pitcher nor any other player be permitted to apply rosin from the bag to their glove or dust any part of the uniform with the rosin bag.

- (b) Intentionally delay the game by throwing the ball to players other than the catcher, when the batter is in position, except in an attempt to retire a runner, or commit an illegal pitch for the purpose of not pitching to the batter (i.e. intentional walk, etc.)

INSTRUCTOR COMMENTS:

- “.....or commit an illegal pitch for the purpose of not pitching to the batter (i.e. intentional walk, etc)”, was added to prevent managers from instructing their pitchers to just drop the ball or start and stop their motion to get the umpire to call an illegal pitch four times thus not requiring the pitcher to throw four pitches to give a batter an intentional walk. Warn the manager that he/she should stop the pitcher from doing this and send the manager home if the pitcher continues to try to beat the rules.

PENALTY: If, after warning by the umpire, such delaying action is repeated, the pitcher can be removed from the game.

INSTRUCTOR COMMENTS:

- The pitcher can be charged with a balk or illegal pitch for unnecessary delaying the game, as an intermediate step before ejection.

- (c) Intentionally pitch at the batter. If in the umpire’s judgment, such violation occurs, the umpire shall warn the pitcher and the manager of the defense that another such pitch will mean immediate expulsion of the pitcher. If such pitch is repeated during the game, the umpire shall eject the pitcher from the game.

8.02 - Challenger

- (a) Adult volunteers may pitch to those players whose coordination and abilities allow them to hit a pitched ball. The pitching distance may be shortened as required when an adult volunteer is pitching.
- (b) The batting tee, positioned at home plate, may be used for players not receiving the pitched ball. The umpire shall place the ball on the tee.
- (c) The pitched ball and batting tee may be used interchangeably throughout the game.

8.03 – When a pitcher takes a position at the beginning of each inning, that pitcher shall be permitted to pitch not to exceed eight preparatory pitches to the catcher, or other teammate acting in the capacity of catcher, during which play shall be suspended. Such preparatory pitches shall not consume more than one minute of time. If a sudden emergency causes a pitcher to be summoned into the game without any opportunity to warm up, the Umpire-in-Chief shall allow the pitcher as many pitches as the umpire deems necessary.

INSTRUCTOR COMMENTS:

- To keep the game moving, enforce this rule.
- The eight preparatory pitches shall be made to the catcher, a practice catcher, or any other player.
- The umpire will control the number of warm up pitches that an incoming pitcher will receive.

8.04 – When the bases are unoccupied, the pitcher shall deliver the ball to the batter within 20 seconds after the pitcher receives the ball. Each time the pitcher delays the game by violating this rule, the umpire shall call “Ball.”

NOTE: The intent of this rule is to avoid unnecessary delays. The umpire shall insist that the catcher return the ball promptly to the pitcher, and that the pitcher take a position on the pitcher’s plate promptly.

8.05 – With a runner or runners on base, it is an illegal pitch – **Major/Minor League [a balk in Intermediate (50-70) Division/Junior/Senior League]** when -

INSTRUCTOR COMMENTS:

- MAJORS/MINOR: With no runners on base you only call an illegal pitch if (e) and/or (g) are committed. Otherwise, call nothing with no runners on base at any level of play.

- (a) the pitcher, while touching the plate, makes any motion naturally associated with the pitch and fails to make such delivery;

EXAMPLE: Comment: If a pitcher swings any part of the free foot past the back edge of the pitcher’s plate, the pitcher is required to pitch to the batter except to throw to second base on a pick-off play. Umpires should bear in mind that the purpose of the balk rule is to prevent the pitcher from deliberately deceiving the base runner. If there is doubt in the umpire’s mind, the “intent” of the pitcher should govern

INSTRUCTOR COMMENTS:

- If the pitcher starts his/her delivery, in any way, and stops, the pitcher has violated the rule. Call a balk or illegal pitch.

- (b) the pitcher, while touching the plate, feints a throw to first base and fails to complete the throw;

INSTRUCTOR COMMENTS:

- A pitcher, while touching the plate, may fake to second or third base PROVIDED the base is occupied and the pitcher steps prior to the fake

- (c) the pitcher, while touching the plate, fails to step directly toward a base before throwing to that base;

INSTRUCTOR COMMENTS:

- Requires the pitcher, while touching the pitcher's plate, to step directly toward a base before throwing to that base. If a pitcher turns or spins off his/her free foot without actually stepping or if he/she turns his/her body and throws before stepping, it is a balk.
- A pitcher is to step directly toward a base before throwing to that base but does not require him/her to throw (except to first base only) because he/she steps. It is possible, with runners on first and third, for the pitcher to step toward third and not throw, merely to bluff the runner back to third; then seeing the runner on first start for second, turn and step toward and throw to first base. This is legal. However, if, with runners on first and third, the pitcher, while in contact with the rubber, steps toward third and then immediately and in practically the same motion "wheels" and throws to first base, it is obviously attempt to deceive the runner at first base, and in such a move it is practically impossible to step directly toward first base before the throw to first base, and such a move shall be called a balk. Of course, if the pitcher steps off the pitcher's plate and then makes such a move, it is not a balk.
- This frequently happens in one of two ways: (1) a left-hander, facing first base, steps toward the plate while throwing to first; and (2) a right-hander, who is facing third base, turns and pivots on the front (left) foot while throwing to first. Both of these moves are balks and should be enforced.
- Both the "jump turn" and the "stutter-step" are legal provided it's a quick and fluid motion. If there is any interruption, call a balk.

- (d) the pitcher, while touching the plate, throws, or feints a throw to an unoccupied base, except for the purpose of making a play;

INSTRUCTOR COMMENTS:

- Throwing to an unoccupied base to make an appeal is acceptable and not a balk.
- An example of a move that would be a balk: A runner on first breaks for second. The pitcher, sensing that the runner is stealing second, turns and throws to second base, while the runner is back at first. Since there was no play at second, call a balk.

- (e) the pitcher makes a quick pitch; Umpires will judge a quick pitch as one delivered before the batter is reasonably set in the batter's box.

NOTE: Rule 8.05(e) is an illegal pitch (Rule 2.00). **Little League (Major)/ Minor League:** The penalty for Rule 8.05(e), regardless of whether there are runners present or not, is a ball. This is an instance in which an illegal pitch, by Little League (Major)/Minor League definition, can occur without runners on base. **Intermediate (50-70) Division/Junior/Senior League:** With runners on base, Rule 8.05(e) is penalized with a balk; with no runners on base, Rule 8.05(e) is penalized with a ball. (See exceptions in "PENALTY.")

INSTRUCTOR COMMENTS:

- A quick pitch is an illegal pitch. In Little League (Minors/Majors and all divisions of softball) a quick pitch is only a ball to the batter with or without runners. In Intermediate (50/70) Division/Junior/Senior League Baseball with runners on base the penalty is a balk; with no runners on base, it is a ball. The quick pitch is dangerous and should not be permitted.
- The only two illegal pitches that are balks with runners on base are in Junior/Senior League Baseball, (1) a quick return pitch and (2) a pitch that is delivered when the pitcher is not in contact with the pitcher's plate.
- Recognize that in the process of turning the foot and pushing off, the pitcher will not be in contact with the pitcher's plate upon delivery. What the rule is trying to prevent is when the pitcher CLEARLY picks up the foot and re-plants the foot CLEARLY in front of the pitcher's plate. This is taking unfair advantage of the hitter.

- (f) the pitcher delivers the ball to the batter while not facing the batter;
 (g) the pitcher makes any motion naturally associated with the pitch while not touching the pitcher's plate;

NOTE: Rule 8.05(g) is an illegal pitch (Rule 2.00). **Little League (Major)/ Minor League:** The penalty for Rule 8.05(g), regardless of whether there are runners present or not, is a ball. This is an instance in which an illegal pitch, by Little League (Major)/Minor League definition, can occur without runners on base. **Intermediate (50-70) Division/Junior/Senior League:** With runners on base, Rule 8.05(g) is penalized with a balk; with no runners on base, Rule 8.05(g) is penalized with a ball. (See exceptions in "PENALTY.")

INSTRUCTOR COMMENTS:

- This is a move clearly designed to deceive the runners and must be called. The pitcher should not get onto the pitcher's plate until he's ready to look in for the sign and then pitch.

- (h) the pitcher unnecessarily delays the game;
 (i) the pitcher, without having the ball, stands on or astride the pitcher's plate or while off the plate feints a pitch;

INSTRUCTOR COMMENTS:

- This is a move clearly designed to deceive the runners and must be called a balk in the Junior/Senior League Baseball programs. The pitcher should not get onto the pitcher's plate until he/she has the ball and he/she is ready to look in for the sign and then pitch.

- (j) the pitcher, while touching the plate, accidentally or intentionally drops the ball;

INSTRUCTOR COMMENTS:

- A ball, which slips out of a pitcher's hand and crosses the foul line shall be, called a ball; otherwise it will be called no pitch. In Intermediate (50/70) Division/Junior/Senior League Baseball this would be a balk with runners on base

- (k) the pitcher, while giving an intentional base on balls, pitches when the catcher is not in the catcher's box

INSTRUCTOR COMMENTS:

- Because of the size of the catcher's box in Little League, it's virtually impossible to get out of the box.
- The catcher must have his/her foot on the ground entirely outside the catcher's box before the pitch is delivered.
- This action occurs only on intentional base on balls, not on "pitch outs" or other situations.

NOTE: There is no balk in Little League, Minor League or Tee Ball.

- (l) **Intermediate (50-70) Division/Junior/Senior League only:** The pitcher, after coming to a legal position, removes one hand from the ball other than in an actual pitch, or in throwing to a base;

INSTRUCTOR COMMENTS:

- This is a nervous habit for many pitchers in the Majors and below. Coaches should make an effort to break pitchers of this habit.
- In Juniors, Seniors and Big League, this is a balk whether it is from the Windup or the Set Position.

- (m) **Intermediate (50-70) Division/Junior/Senior League only:** The pitcher delivers the pitch from the set position without coming to a stop.

INSTRUCTOR COMMENTS:

- In Majors and below, it is not necessary to stop prior to delivery. Pitchers can also windup from Set Position.
- In Intermediate (50/70) Division/Juniors, Seniors and Big League, the pitcher may step and throw to a base at any time during the stretch. However, the pitcher must come to a stop before delivering the ball to the batter. A change of direction is not considered a stop.
- A "change of direction" is not considered a stop.

NOTE 1: Little League (Major) and Minor League - 8.05(l) and 8.05(m) shall not be enforced at any time.

NOTE 2: A batter hit by a pitch shall be awarded first base without reference to the illegal pitch.

INSTRUCTOR COMMENTS:

- Don't award the batter first base if he/she would not have been awarded first base if the pitch had been legal. **Rule 6.08(b)** In such a case enforce the illegal pitch.

PENALTY FOR AN ILLEGAL PITCH: Little League (Major)/Minor League: The ball is dead and no runners will advance. The pitch shall be called a ball even if the pitch is not actually thrown. **EXCEPTION:** If the pitch is delivered and a play follows the illegal pitch, the play shall be allowed to continue as a delayed dead ball. Upon completion of the play, the manager of the offense may advise the plate umpire of a decision to decline the illegal pitch penalty and accept the play. Such election shall be made immediately at the end of the play. However, if the batter hits the ball and reaches first base safely, and if all base-runners advance at least one base on the action resulting from the batted ball, the play proceeds without reference to the illegal pitch.

When an illegal pitch is called, regardless of whether the pitch is completed or not by the pitcher, a pitch will always be charged to the pitcher's pitch count. (Rule 2.00 Definitions: Pitch) **NOTE:** Under no circumstances shall a balk be called in Little League (Major) or Minor League.

PENALTY FOR A BALK: The balk applies only to **Intermediate (50-70) Division/ Junior/Senior League.** The ball is dead, and each runner shall advance one base without liability to be put out unless the batter reaches first on a hit, an error, a base on balls, a hit batter, or otherwise, and all other runners advance at least one base in which case the play proceeds without reference to the balk. When a balk is called and the pitch is delivered it will be considered neither a ball nor strike unless the pitch is ball four (4) awarding the batter first base and forcing all runners on base to advance.

When a balk is called, if the pitch is delivered, a pitch shall be charged against the pitch count regardless of whether the batter put the pitch into play. However, on a balk that is called on a pickoff attempt or in an instance that the pitcher does not deliver the pitch, no pitch shall be charged to the pitch count.

NOTE: Umpires should bear in mind that the purpose of the balk rule is to prevent the pitcher from deliberately deceiving the base runner. If there is doubt in the umpire's mind, the "intent" of the pitcher should govern. However, certain specifics should be borne in mind:

- (1) Straddling the pitcher's plate without the ball is to be interpreted as intent to deceive and ruled a balk.
- (2) With a runner on first base and the runner attempting to steal second, the pitcher may make a complete turn, without hesitating toward first, and throw to second. This is not to be interpreted as throwing to an unoccupied base.

EXAMPLE: A major problem we have is umpires calling "time" when a pitcher balks. If the pitcher is in the act of delivering the ball, just yell "balk" and stay down and call the pitch.

INSTRUCTOR COMMENTS:

- If the pitch is delivered, it's neither a ball nor a strike UNLESS the pitch is ball four awarding the batter first base and any other runners advance because of the ball four award. If they don't all advance as a result of the ball four award, enforce the balk, nullify the walk and bring the batter back up to bat.

(Intermediate 50/70/Junior/Senior League) A.R. 1—If the pitcher violates (a) through (m) in this rule and throws wild to a base, the runner or runners may advance at their own risk. (Delayed dead ball.)

EXAMPLE: Comment: If the pitcher “balks” in throwing to a base, yell “balk” and wait to see what happens on the play. (Rule 8.05 Approved Ruling (1)).

(Intermediate 50/70/Junior/Senior League) A.R. 2—A runner who misses the first base to which that runner is advancing and who is called out on appeal shall be considered as having advanced one base for the purpose of this rule.

8.06 – This rule, which applies to each pitcher who enters a game, governs the visits of the manager or coach to the pitcher **at the mound**.

- (a) A manager or coach may come out ***once (Minor Division: twice)** in one inning to visit with the pitcher, but the ***second time (Minor Division: third time)** out the player must be removed as a pitcher. **Example:** If a manager visits Pitcher A once in the first inning, then makes a pitching change in the same inning, Pitcher B would be allowed ***one** visits in that inning before being removed on the ***second** visit.
- (b) A manager or coach may come out ***twice (Minor Division: three times)** in one game to visit with the pitcher, but the ***third time (Minor Division: fourth time)** out, the player must be removed as a pitcher. **Example:** If a manager visits Pitcher A twice in the first three innings, then makes a pitching change in the fourth inning, Pitcher B would be allowed ***two** visits in that game before being removed on the ***third** visit, subject to the limits in (a) above.

NOTE: A pitcher moving to a different position and returning as the pitcher of record shall retain the number of visits from their previous appearance as pitcher. To calculate the number of visits for a pitcher, all visits, regardless of the pitcher being removed and returned to the pitcher’s position, shall be applied.

- (c) A manager or coach may confer with any other player(s), including the catcher, during the visit with the pitcher. A manager or coach who is granted a time out to talk to any defensive player will be charged with a visit to the pitcher

A.R. 1— At the time a pitcher is removed, a visit shall not be charged to the new pitcher.

A.R. 2—A conference with the pitcher or any other fielder to evaluate the player’s condition after an injury shall not be considered a visit for the purposes of this rule. The manager or coach should advise the umpire of such a conference, and the umpire should monitor same.

EXAMPLE: If the manager or coach after a warning, makes a third visit to the pitcher while the same batter is at bat, the manager or coach shall be removed from the game, not the pitcher.

INSTRUCTOR COMMENTS:

- ➔ A manager is allowed to visit with any defensive player. If the manager or coach comes out and only talks to the shortstop or only to the 3rd baseman he/she is still charged with a visit to the pitcher. The manager or coach, in all Divisions, may go to the mound or foul line, whichever he/she prefers.
- ➔ At times, managers will call a catcher over to the dugout in an effort to avoid being charged a conference. This is not allowed and additional visits must be charged to the pitcher.
- ➔ When a manager comes out and makes a pitching change that shall not be considered a visit to the pitcher being replaced. This applies to Junior/ Senior League Softball and Baseball where a pitcher may move to another position and return as a pitcher later in the same game.

8.00 - THE PITCHER (SOFTBALL)

- (a) A legal pitching delivery shall be a ball that is delivered to the batter in an underhand motion.
- (b) Both feet must be on the ground within or partially within the 24-inch length of the pitcher's plate.

INSTRUCTOR COMMENTS:

→ Whether the pitcher chooses to have only the pivot foot or both feet in contact with the pitcher's plate, the non-pivot foot may not extend beyond the limit of the pitcher's plate (toward first base or toward third base).

- (c) The shoulders shall be in line with first and third bases. When taking the pitching position, the pitcher must have his/her hands separated and must have the ball in either the glove or the pitching hand.

INSTRUCTOR COMMENTS:

→ This position means that the shoulders should be parallel with a line extending from first base to third base.

- (d) Prior to pitching, the pitcher shall take a position with his/her pivot foot in contact with the pitcher's plate. This contact must be on or partially on the top surface of the pitcher's plate. The non-pivot foot must be on or behind the pitcher's plate.

Note: Not just two (2) feet on the pitcher's plate, but one or two (2), the pitcher has the choice.

- (e) While on the pitching plate, the pitcher shall take the signal or appear to be taking a signal with the hands separated. The ball must remain in either the glove or pitching hand.

INSTRUCTOR COMMENTS:

→ The pitcher can take signs from the manager or coach as long as she is standing on the pitcher's plate. If not done, after warning, she can be removed from the game.

- (f) After completing (e) above, the pitcher shall bring the hands together in front of the body for not less than one second and not more than 10 seconds before starting the delivery.

INSTRUCTOR COMMENTS:

→ Umpires should be aware that this rule is designed to prevent the pitcher from (1) quick-pitching the batter and (2) unnecessarily delaying the game. Develop a feel for whether or not this is being abused

- (g) A backward step may be taken before or simultaneous with the hands being brought together. The pivot foot must remain in contact with the pitching plate at all times prior to the forward step.

A.R.—If the hands are together while in the pitching position, the pitcher may not step back.

EXAMPLE: (1) Prior to bringing the hands together, or simultaneous with bringing the hands together, a pitcher may take one step back with the non-pivot foot before delivering the pitch to the batter. However, if the pitcher starts his/her delivery with only one hand on the ball, he/she may also take a step back with the non-pivot foot.

EXAMPLE: (2) There are two (2) approved deliveries (a) windmill - the "windmill" pitch occurs when the pitcher makes a full and complete revolution with the pitching arm. (b) slingshot - the "slingshot" pitch occurs when the pitcher turns her body toward first or third base and bends her elbow during the back swing, then whips (slingshots around to the plate.)

INSTRUCTOR COMMENTS:

- The Note above allows the pitcher to take a step backwards, but only if the hands were apart before the step. If the hands are together while in the pitching position, the pitcher may not step back.
- The hands must be brought together simultaneous with, during or after the backward step.

- (h) In the act of delivering the ball, the pitcher may take one step with the non-pivot foot simultaneously with the release of the ball. The step must be forward and toward the batter within or partially within the 24-inch length of the pitcher's plate. **NOTE:** It is not a step if the pitcher slides the pivot foot across the pitcher's plate toward the batter, or if the pivot foot turns or slides in order to push off the pitcher's plate, provided contact is maintained with the plate. Raising the foot off the pitching plate and returning it to the plate creates a rocking motion and is an illegal act.

INSTRUCTOR COMMENTS:

→ This "sliding foot" is typically the pivot foot. Do not allow her to slide this foot off the pitcher's plate.

- (i) The pitcher shall not be considered in the pitching position unless the catcher is in position to receive the pitch

A.R.—The catcher is considered to be in position to receive a pitch when his/her mask is on and is facing the pitcher. It is not necessary to be in a squatting position.

INSTRUCTOR COMMENTS:

- ➔ With the current size of the catcher's box, it's virtually impossible for the catcher to be outside these lines.
- ➔ Returning the pitched ball to the pitcher keeps the ball game moving.
- ➔ In a study of **Softball Rule 7.08(a-5)**, the catcher's position has no bearing on stopping the runner.
- ➔ However, when the pitcher moves to the pitcher's plate, the catcher should be in position.
- ➔ The catcher is not considered in position to receive the pitch, unless she has her mask on and is facing the pitcher. It is not necessary for her to be in a squatting position.

- (j) The pitcher may not take the pitching position on the pitcher's plate without having the ball in his/her possession.
- (k) The pitch starts when one hand is taken off the ball after the hands have been placed together.
- (l) The pitcher must not make any motion to pitch without immediately delivering the ball to the batter.

INSTRUCTOR COMMENTS:

- ➔ It is not illegal for the pitcher to strike or brush her hip in the delivery of the ball to the batter.
- ➔ The so-called "hesitation" pitch is illegal. There should be no pause in the forward motion.

- (m) The pitcher must not use a pitching motion in which, after bringing the hands together, the pitcher removes one hand from the ball, and returns the ball to both hands in front of the body.
- (n) The pitcher must not make a stop or reversal of the forward motion after separating the hands.
- (o) The pitcher must not make two revolutions of the arm in the windmill motion. A pitcher may drop the arm to the side and to the rear before starting the windmill motion. If the windmill motion is not used the ball must be delivered toward home plate on the first forward swing of the pitching arm past the hip.
- (p) The delivery must be an underhanded motion with the hand below the hip and the wrist not farther from the body than the elbow.

INSTRUCTOR COMMENTS:

- ➔ With the speed of the deliveries, it can be difficult to determine. If not sidearm, it's probably legal.

- (q) The release of the ball and follow through of the hand and wrist must be forward and past the straight vertical line of the body.
- (r) Pushing off with the pivot foot from a place other than the pitcher's plate is illegal. This includes a "crow hop" as defined under Rule 2.00.
- (s) The pivot foot must remain in contact with or push off and drag away from the pitching plate prior to the front foot touching the ground, as long as the pivot foot remains in contact with the ground. When the pivot foot leaves the ground it is considered a "leap" and is considered an illegal pitch. See definition under Rule 2.00.

INSTRUCTOR COMMENTS:

- ➔ Definitions for both the "Crow Hop" and "Leaping" are found in Rule 2.00. They are both illegal pitches.
- ➔ This rule is intended to make it more difficult for the pitcher to get away with a "crow hop" delivery.

- (t) The pitcher must not make another revolution after releasing the ball.
- (u) The pitcher shall not deliberately drop, roll, or bounce the ball in order to prevent the batter from hitting it.

INSTRUCTOR COMMENTS:

- ➔ Please note that this differs from the ball slipping from the hand that is covered in Rule 8.07(a).

- (v) The pitcher has 20 seconds to release the next pitch after receiving the ball or after the umpire indicates "play ball."

PENALTY: The penalty imposed for violation of all subsections of rule 8.01, with the exception of subsection (i), is an illegal pitch. Violation of (i) is ruled as a No Pitch. **Minor/Major Divisions:** The pitch shall be called a ball. If a play follows the illegal pitch, the manager of the offense may advise the plate umpire of a decision to decline the illegal pitch penalty and accept the play. Such election shall be made immediately at the end of the play. However, if the batter hits the ball and reaches first base safely, and if all base runners advance at least one base on the action resulting from the batted ball, the play proceeds without reference to the illegal pitch. **Junior/Senior League:** The pitch shall be called a ball and all base runners advance one base without liability to be put out. If a play follows the illegal pitch, the manager of the offense may advise the plate umpire of a decision to decline the illegal pitch penalty and accept the play. Such election shall be made immediately at the end of the play. However, if the batter hits the ball and reaches first base safely, and if all base runners advance at least one base on the action resulting from the batted ball, the play proceeds without reference to the illegal pitch.

NOTE: **Minor/Major Divisions:** A batter hit by a pitch shall be awarded first base without reference to the illegal pitch. **Junior/Senior Divisions:** A batter hit by a pitch shall be awarded first base and all base runners advance one base without reference to the illegal pitch.

8.02 - The pitcher shall not -

- (a) (1) apply a foreign substance of any kind to the ball, pitching hand, or fingers. Under the supervision of the umpire, powder rosin may be used to dry the hands; **NOTE:** A pitcher may use a rosin bag for the purpose of applying rosin to the bare hand or hands. Neither the pitcher nor any other player shall dust the ball with the rosin bag; neither shall the pitcher nor any other player be permitted to apply rosin from the bag to their glove or dust any part of the uniform with the rosin bag.

INSTRUCTOR COMMENTS:

- Softball presently does not have the rule that will charge an automatic ball to the batter for bringing the pitching hand to the mouth or lips while in the circle. This is a **Baseball** rule. However, if the umpire is convinced that by doing so, the pitcher either defaces the ball (see 3 below) or gains an unfair advantage, it is an illegal pitch.
- Unless you are absolutely certain that an advantage is gained, there is no infraction.

- (2) wear a sweatband, bracelet, or similar type items on the wrist or forearm the pitching arm. Items worn on the glove arm must be of a solid, single color: black, white, gray, or uniform color. See also Rule 1.15(c).
- (3) deface the ball in any manner;

INSTRUCTOR COMMENTS:

- Some umpires will incorrectly hold up one hand, indicating to the pitcher not to pitch. Do not do this unless your intention is to call "Time". Either the ball is in play or it's not. There is no "in-between". If the pitcher is quick pitching, penalize her with an illegal pitch.

- (b) intentionally delay the game by throwing the ball to players other than the catcher, when the batter is in position.

PENALTY: If, after a warning by the umpire, such delaying action is repeated, the pitcher can be removed from the game.

INSTRUCTOR COMMENTS:

- This penalty does not preclude the umpire from enforcing the illegal pitch when it occurs. If it continues, then eject the pitcher.

8.03 -

- (a) At the beginning of each inning or when a pitcher relieves another, no more than one minute may be used to deliver not more than eight preparatory pitches to the catcher or other teammate acting in the capacity of catcher.

A.R.—If a sudden emergency causes a pitcher to be summoned into the game without any opportunity to warm-up, the umpire-in-chief shall allow the pitcher as many pitches as the umpire deems necessary.

INSTRUCTOR COMMENTS:

- The eight preparatory pitches shall be made to the catcher, a practice catcher, or any other player.
- The umpire will control the number of warm up pitches that an incoming pitcher will receive.
- If a sudden emergency causes a pitcher to be summoned into the game without any opportunity to warm up, the plate umpire shall allow the pitcher as many pitches as the UMPIRE deems necessary.

- (b) The catcher shall return the ball directly to the pitcher after each pitch, except after a strikeout or putout made by the catcher, or to make a play on a base runner.
- (c) If the pitcher desires to walk a batter intentionally, all pitches must be legally delivered to the batter.

8.04 - "No Pitch" shall be declared and the ball is dead when -

- (a) the pitcher pitches during the suspension of play;
- (b) the runner is called out for leaving the base too soon;
- (c) a catcher's feet (both) are not within the catcher's box while the pitcher has the ball and is ready to pitch. Once the ball is released, the catcher may step outside the box.

8.05 - An Illegal Pitch is -

- (a) pushing off with the pivot foot from a place other than the pitcher's plate. The pivot foot may remain in contact with or may push off and drag away from the pitching plate prior to the front foot touching the ground, as long as the pivot foot remains in contact with the ground and within or partially within the 24- inch length.

INSTRUCTOR COMMENTS:

- This rule will also include when either of the pitcher's feet is extended beyond the outside ends of the pitcher's plate.
- This also includes the "crow hop" and "leap". The pivot foot may, however, drag away from the pitcher's plate.

- (b) when the pitcher delivers the pitch with a foreign substance applied to the ball; (Rosin can be applied to the hand).
- (c) a "quick" return pitch;
- (d) a pitch not made in accordance with the pitching rules.
- (e) a throw to a base while the pivot foot is in contact with the pitcher's plate.

PENALTY: Minor/Major Divisions: The pitch shall be called a ball. If a play follows the illegal pitch, the manager of the offense may advise the plate umpire of a decision to decline the illegal pitch penalty and accept the play. Such election shall be made immediately at the end of the play. However, if the batter hits the ball and reaches first base safely, and if all base runners advance at least one base on the action resulting from the batted ball, the play proceeds without

reference to the illegal pitch. **Junior/ Senior League:** The pitch shall be called a ball and all base runners advance one base without liability to be put out. If a play follows the illegal pitch, the manager of the offense may advise the plate umpire of a decision to decline the illegal pitch penalty and accept the play. Such election shall be made immediately at the end of the play. However, if the batter hits the ball and reaches first base safely, and if all base runners advance at least one base on the action resulting from the batted ball, the play proceeds without reference to the illegal pitch.

NOTE 1: A batter hit by a pitch shall be awarded first base without reference to the illegal pitch. **Junior/Senior Divisions:** A batter hit by a pitch shall be awarded first base and all base runners advance one base without reference to the illegal pitch.

NOTE 2: There is no balk in softball.

INSTRUCTOR COMMENTS:

- ➔ Note that the only penalty is a "Ball" to the batter at Majors and below, at Junior/Senior level base runners are advanced one base, at Majors and below; Junior /Senior base runners advance one base.

8.06 This rule, which applies to each pitcher who enters a game, governs the visits of the manager or coach to the pitcher in the circle.

- (a) A manager or coach may come out ***once (Minor Division: twice)** in one inning to visit with the pitcher, but the ***second time (Minor Division: third time)** out, the player must be removed as a pitcher. **Example:** If a manager visits Pitcher A once in the first inning, then makes a pitching change in the same inning, Pitcher B would be allowed ***one** visits in that inning before being removed on the ***second** visit.
- (b) A manager or coach may come out ***twice (Minor Division: three times)** in one game to visit with the pitcher, but the ***third time (Minor Division: fourth time)** out, the player must be removed as a pitcher. **Example:** If a manager visits Pitcher A twice in the first three innings, then makes a pitching change in the fourth inning, Pitcher B would be allowed ***two** visits in that game before being removed on the ***third** visit, subject to the limits in (a) above.

NOTE: A player removed from the pitcher's plate and returning as the pitcher of record shall retain the number of visits from their previous appearance as pitcher. To calculate the number of visits for a pitcher, all visits, regardless of the pitcher being removed and returned to the pitcher's position, shall be applied.

- (c) A manager or coach may confer with **any other player(s)**, including the catcher, during the visit with the pitcher. A manager or coach who is granted a time out to talk to any defensive player will be charged with a visit to the pitcher

A.R. 1— At the time a pitcher is removed, a visit shall not be charged to the new pitcher.

A.R. 2—A conference with the pitcher or any other fielder to evaluate the player's condition after an injury shall not be considered a visit for the purposes of this rule. The manager or coach should advise the umpire of such a conference, and the umpire should monitor same.

INSTRUCTOR COMMENTS:

- ➔ If the manager or coach, after a warning, makes a third visit to the pitcher while the same batter is at bat, the manager or coach shall be removed from the game, not the pitcher.
- ➔ If a manager requests time to talk to his pitcher, the offensive manager also will be allowed to talk to his batter or runner without being charged with an offensive time-out.
- ➔ A manager is allowed to visit with any defensive player. The manager or coach, in all Divisions, may go to the mound or foul line, whichever he/ she prefers.
- ➔ At times, managers will call a catcher over to the dugout in an effort to avoid being charged a conference. This is not allowed and must be charged to the pitcher.
- ➔ When a manager comes out and makes a pitching change that shall not be considered a visit to the pitcher being replaced. This applies to all divisions of softball where a pitcher may move to another position and return as a pitcher later in the same game.

8.07 - Dropped Ball

- (a) If a ball slips from the pitcher's hand before, during, or up to the delivery of a pitch, a ball is declared on the batter. The ball will remain in play and the runner(s) may advance at their own risk. See Rule 2.00 - Dropped Ball.

INSTRUCTOR COMMENTS:

- ➔ In all divisions, in this situation, runners may advance as soon as the ball slips from the pitcher's hand. The ball is live and in play
- ➔ Dropped Ball – Is a ball which slips from the pitcher's hand after the pitcher takes a position on the pitcher's plate, or goes directly from the pitcher's hand straight to the ground during the pitcher's motion. A dropped ball can occur while the pitcher is just standing on the pitcher's plate; during the back swing or up to the delivery of the pitch in the windmill motion. A drop is distinguished from a pitch in that a pitch must have lift and carry pass the release of the hip and a drop slips from the hand or goes straight and direct to the ground.

RULE 9.00 THE UMPIRE

9.01 -

- (a) The league president shall appoint one or more adult umpires to officiate at each league game. The umpire shall be responsible for the conduct of the game in accordance with these official rules and for maintaining discipline and order on the playing field during the game.

BASEBALL NOTE 1: Plate umpire must wear mask, shin guards and chest protector. Male umpires must wear protective cup.

BASEBALL NOTE 2: It is highly recommended all umpires attach a “dangling” type throat protector to their mask.

SOFTBALL NOTE 1: It is highly recommended all umpires attach a “dangling” type throat protector to their mask.

SOFTBALL NOTE 2: Male umpires working the game behind the plate must wear mask, chest protector, and protective cup.

SOFTBALL NOTE 3: Female umpires working the game behind the plate must wear mask and chest protector.

SOFTBALL NOTE 4: Use of protective shin guards is strongly recommended as a safety precaution for both male and female umpires working behind the plate.

TEE BALL: Managers and coaches may be used as umpires

INSTRUCTOR COMMENTS:

- While the throat protector is not mandatory for the plate umpire, it is highly recommended if the umpire is utilizing the inside chest protector. With the outside (or balloon-type) chest protector, the throat protector is less effective.

- (b) Each umpire is the representative of the league and of Little League International, and is authorized and required to enforce all of these rules. Each umpire has authority to order a player, coach, manager, or league officer to do or refrain from doing anything which affects the administering of these rules and to enforce the prescribed penalties.

INSTRUCTOR COMMENTS:

- The umpires are obligated to abide by these rules. Leagues cannot change the Playing Rules unless permission is given through listed options in one of the Little League Rules Books

- (c) Each umpire has authority to rule on any point not specifically covered in these rules.

INSTRUCTOR COMMENTS:

- Seldom will an umpire have to utilize this rule. Most situations can be covered by rules and interpretations listed throughout the book. Umpires should not use Rule 9.01(c) as a substitute for knowledge of the rules or to further their individual agendas utilizing the word “safety”.
- Situations such as throwing the bat and other potentially unsafe actions should be covered as follows: Warn the player and warn the other members of this player’s team. After the warnings highly recommend to the manager of the offending team that it is time to substitute for the offender until they are properly schooled in the proper method of discarding the bat after the ball is hit. While there is no easy solution to this problem ultimately the responsibility rests with the team manager for teaching the players the proper way to discard a bat.

- (d) Each umpire has authority to disqualify any player, coach, manager, or substitute for objecting to decisions or for unsportsmanlike conduct or language and to eject such disqualified person from the playing field. If an umpire disqualifies a player while a play is in progress, the disqualification shall not take effect until no further action is possible in that play.

NOTE: The local league has the option to adopt this rule application. The stealing and relaying of signs to alert the batter of pitch selection and/or location is unsportsmanlike behavior. If, in the judgment of the umpire, this behavior is occurring, those responsible including any player(s), coach(es), and/or manager shall be ejected from the game.

INSTRUCTOR COMMENTS:

- Keep in mind that the unsportsmanlike conduct or language could exist toward an umpire, the opposing team, and even a member of the same team. Do not allow bad behavior to continue, even if it’s not directed at you.

- (e) A manager, coach, or player shall not leave their position in the field or bench area during a fight or physical confrontation; a manager or coach who attempts to prevent a fight or restore order, in the umpire’s judgment, is not in violation of this rule.

PENALTY: The umpire shall eject the offender(s) from the game immediately. Failure to comply with the ejection may result in the umpire suspending the game and referring it to the Board of Directors for further action.

- (f) All umpires have authority at their discretion to eject from the playing field (1) any person whose duties permit that person’s presence on the field, such as ground crew members, photographers, newsmen, broadcasting crew members, etc., and (2) any spectator or other person not authorized to be on the playing field.
- (g) Umpires may order both teams into their dugouts and suspend play until such time as league officials deal with unruly spectators. Failure of league officials to adequately handle an unruly spectator can result in the game remaining suspended until a later date.

9.02 -

- (a) Any umpire’s decision which involves judgment, such as, but not limited to, whether a batted ball is fair or foul, whether a pitch is a strike or a ball, or whether a runner is safe or out, is final. No player, manager, coach or substitute shall object to any such judgment decisions.

INSTRUCTOR COMMENTS:

→ Arguing on BALLS AND STRIKES should not and will not be condoned. Teams should be warned that if they start for the plate to protest the calls they could face an ejection.

EXAMPLE 1: each umpire has an area of responsibility and each umpire should not get caught in the other umpire's area. (Hand in the cookie jar, so to speak) There are times a home plate umpire will be required to make a call on the bases and vice versa. In other words, if you need help, ask before making a call.

EXAMPLE 2: Swipe tag at first, base umpire does not see a tag, he/she should not make a call, but ask for help..."Did he/she get him/her?" Plate umpire would signal "out" if tag were made and "safe" if tag were missed. Same applies to pulled foot at a base, etc. If a call is made, you live with the call, right or wrong. **Comment:** (2) a strike call on half swing may not be appealed. A good rule of thumb to use on a half swing; Right Handed Batter: If the barrel of the bat is pointed at or past the first base line, it has gone far enough....Call it a strike! Left Handed Batter: If the barrel of the bat is pointed at or past the third base line, it has gone far enough....Call it a strike!

→ There is probably no other rule more important to an umpire. Judgment calls are final. Work to get the call right and resist the frequent requests to check with another umpire.

→ It is customary and highly recommended that the plate umpire check on a half-swing called a "ball" if he/she has doubt.

→ If there is a question as to whether or not a batted ball is fair or foul, leave it in play. You can always return the runners if you discover the ball foul. If you call it "Foul", however, you've killed the play. However, if the ball is a fly ball and you inadvertently call "Foul" and the ball is caught, it is still a fly ball out.

→ On pitched balls, in order to call a pitch a strike, you must see either the ball in the strike zone OR the batter swing at the pitch. If you see neither, it must be a ball.

→ In order to call an out, you must see something happen, i.e., runner tagged, ball caught, ball beat a runner to a base, etc. If not, he/she must be safe. Don't guess out. Make sure.

→ **No umpire may overrule another umpire on any judgment call! PERIOD! EXCLAMATION POINT!**

- (b) If there is reasonable doubt that any umpire's decision may be in conflict with the rules, the manager may appeal the decision and ask that a correct ruling be made. Such appeal shall be made only to the umpire who made the protested decision.

INSTRUCTOR COMMENTS:

→ This, of course, does NOT apply to judgment calls, just rules decisions.

- (c) If a decision is appealed, the umpire making the decision, may ask another umpire for information before making a final decision. No umpire shall criticize, seek to reverse, or interfere with another umpire's decision unless asked to do so by the umpire making it.

INSTRUCTOR COMMENTS:

→ Keep in mind that the umpire who has made the rules decision is the only one who may initiate the discussion. Regardless of the experience or knowledge, no other umpire may force the discussion or overrule the decision. If a manager has a concern with a rules decision, he/she must take

→ his/her case to the umpire who made the decision.

→ Checking with another umpire is not required. **No umpire can overrule another umpire.**

- (d) No umpire may be replaced during a game unless injured or ill.

INSTRUCTOR COMMENTS:

→ Recognize, however, that Little League umpires are volunteers. The umpire's needs may require him/her to be replaced. Nobody else, including the league president, however, can "force" an umpire's replacement after a game has started.

9.03 -

- (a) If there is only one umpire, and that umpire is a non-adult there must be a Game Coordinator at the game site. The umpire shall have complete jurisdiction, in conjunction with Rule 9.03 (d) in administering the rules. This umpire may take any position on the playing field which will enable said umpire to discharge all duties (usually behind the catcher, but sometimes behind the pitcher if there are runners.)

INSTRUCTOR COMMENTS:

→ Since most decisions for an umpire will be balls and strikes, the most effective place to work is behind the plate.

- (b) If there are two or more umpires, one shall be designated umpire-in chief and the others, field umpires or a plate umpire.
- (c) The umpire-in-chief may be a plate umpire or a field umpire. The umpire-in-chief's duties, in addition to any field or plate duties, shall be to:
- (1) take full charge of, and be responsible for, the proper conduct of the game;
 - (2) make all decisions except those commonly reserved for the other field umpires or plate umpire; (3) announce any special ground rules;

- (d) If no adult umpire is available for a game, and non-adult umpires are used exclusively for that game, the local Little League must assign an adult as Game Coordinator, or the game cannot be played. The Game Coordinator must not be a manager or coach of either team in the game, and cannot be assigned as Game Coordinator for more than one game at a time. The Game Coordinator's duties shall be:
- (1) To be included in the pre-game meeting as noted in Rule 4.01.
 - (2) To remain at the game at all times, including between half-innings, in a position to see all actions on the field and in close proximity to the field (not in any enclosure. If, for some reason, the Game Coordinator is not present or is unable to perform his/her duties for any reason, the game must be suspended until the Game Coordinator returns, or until a new adult Game Coordinator is present and assumes the duties of Game Coordinator for the remainder of the game;
 - (3) To oversee the conduct of all players, managers, coaches and umpires in the game;
 - (4) To have the authority to disqualify any player, coach, manager, or substitute for objecting to the decisions of an umpire, for unsportsmanlike conduct or language, or for any of the reasons enumerated in these Playing Rules, and to eject such disqualified person from the playing field. If the Game Coordinator disqualifies a player while a play is in progress, the disqualification shall not take effect until no further action is possible in that play;
 - (5) To have the sole ability to judge as to whether and when play shall be suspended during a game because of inclement weather conditions or the unfit condition of the playing field; as to whether and when play shall be resumed after such suspension; and as to whether and when a game shall be terminated after such suspension. Said Game Coordinator shall not call the game until at least thirty minutes after play as suspended. The Game Coordinator may continue suspension as long as there is any chance to resume play. (This supersedes Rule 3.10.)

A.R.—The Game Coordinator should not interrupt or stop a game until all play and action ends. At that time, the Game Coordinator can alert the plate umpire to stop the game, and at that time enforce any part of 9.03(d).

INSTRUCTOR COMMENTS:

- The Game Coordinator should not interrupt or stop a game until all play and action ends. At that time, the Game Coordinator can alert the plate umpire to stop the game, and at that time enforce any part of 9.03 (d)

9.04-

- (a) The plate umpire shall stand behind the catcher. This umpire usually is designated as the umpire-in-chief. The plate Umpire's duties shall be to:
- (1) Call and count ball and strikes;
 - (2) Call and declare fair balls and fouls except those commonly called by field umpires;

INSTRUCTOR COMMENTS:

- Review the procedures for half-swings listed in the comments following Rule 9.02(a).

- (3) Make all decisions on the batter except those specifically reserved to the umpire-in-chief, or the field umpire;

INSTRUCTOR COMMENTS:

- The plate umpire is responsible for fair and foul calls on balls up to first or third base. Over the base and beyond is the responsibility of the base umpire. Of course, if there is no base umpire on the foul line, the responsibility is that of the plate umpire

- (4) Inform the official scorer of the official batting order; and any changes in the lineups and batting order, on request.

- (b) A field umpire may take any position (see Little League Umpire Manual) on the playing field best suited to make impending decisions on the bases. A field umpire's duties shall be to:
- (1) make all decisions on the bases except those specifically reserved to the umpire-in-chief, or the plate umpire
 - (2) take concurrent jurisdiction with the Umpire-in-Chief in calling "Time", illegal pitches, (**Baseball: Intermediate (50/70) Junior/Senior League** balks), or defacement or discoloration of the ball by any player;
 - (3) aid the umpire-in-chief in every manner in enforcing the rules, and excepting the power to forfeit a game, shall have equal authority with the umpire-in-chief in administering and enforcing the rules and maintaining discipline.

INSTRUCTOR COMMENTS:

- Frequently, leagues have an experienced umpire behind the plate and a "rookie" or less-experienced umpire working the bases, thinking that the plate umpire "controls" all of the action, expecting him/her to make all of the tough calls and other decisions such as Balks, Illegal Pitches, Infield Fly, and such. The field umpires not only have equal authority to make these calls, but, in many cases, have the primary responsibility for these decisions.

- (c) If different decisions should be made on one play by different umpires, the umpire-in-chief shall call all the umpires into consultation, with no manager or player present. After consultation, the umpire-in-chief shall determine which decision shall prevail, based on which umpire was in the best position and which decision was most likely correct. Play shall proceed as if only the final decision had been made.

INSTRUCTOR COMMENTS:

- This is the only occasion where one umpire has authority to “overrule” another umpire. Umpires should, however, work to understand proper mechanics and communication that will keep this situation from arising.

9.05-

- (a) The umpire shall report to the league president within twenty-four hours after the end of a game all violations of rules and other incidents worthy of comment, including the disqualification of any manager, coach or player, and the reasons therefore.
- (b) When any manager, coach or player is disqualified for a flagrant offense such as the use of obscene or indecent language, or an assault upon an umpire, manager, coach or player, the umpire shall forward full particulars to the league president within twenty-four hours after the game.
- (c) After receiving the umpire’s report that a manager, coach or player has been disqualified, the league president shall require such manager, coach or player to appear before at least three members of the Board of Directors to explain his/her conduct. In the case of a player, the manager shall appear with the player in the capacity of an advisor. The members of the Board present at the meeting shall impose such penalty as they feel is justified.

NOTE: The Board may impose such penalties that they feel are warranted, but may not lessen the requirements of rule 4.07.

INSTRUCTOR COMMENTS:

- If a manager, coach or player is ejected from a game the provisions of rule 4.07 must be followed. However, the Board may elect to increase the suspension, or terminate, etc. However, the Board may not make the penalty less than what rule 4.07 calls for.
- The umpire is the representative of the league president on the field. If there is a situation, circumstance or behavior that needs attention or needs to be corrected, he/she must inform the president of the facts.
- If you don’t report incidents, expect them to occur again.....and again.....and again!

9.06 - Umpires shall not wear shoes with metal spikes or cleats.

IMPORTANT

Carry your rulebook. It is better to consult the Rules and hold up the game long enough to decide a knotty problem than to have a game protested and possibly replayed

INSTRUCTOR COMMENTS:

- Inexperienced umpires should keep the rulebook with them. Others should keep it handy for consultation.
- Do not allow managers to have you show them the rule. That’s not your job. Your job is to call the game. If he/she wants to protest let him/her do it, even if it’s a judgment call. He’ll find out soon enough that judgment calls are not protestable.
- You are going to make mistakes, but never attempt to “even up” after having made one. Make all decisions as you see them and forget which is the home or visiting club.
- Keep your eye everlastingly on the ball while it is in play. It is more vital to know just where a fly ball fell, or a thrown ball finished up, than whether or not a runner missed a base. Do not call the plays too quickly, or turn away too fast when a fielder is throwing to complete a double play. Watch out for dropped balls after you have called a man out.
- Do not come running with your arm up or down, denoting “out” or “safe.” Wait until the play is completed before making any arm motion.
- If you are sure you got the play correct, do not be stampeded by players’ appeals to “ask the other umpire.” If you are not sure, ask one of your associates. Do not carry this to extremes, be alert and call your own plays. But remember! The first priority is to get decisions correct. If in doubt don’t hesitate to consult your associate. Umpire dignity is important but never as important as “getting the call right.”
- A most important rule for an umpire is always “BE IN POSITION TO SEE EVERY PLAY.” Even though your decision may be 100 percent right, someone will still question it if they feel you were not in a spot to see the play clearly and definitely.
- Finally, be courteous, impartial and firm and you will earn respect from all.

SAVE ON

UMPIRE SUPPLIES AND RESOURCES

1. STAY CONNECTED WITH NEW RULES & REGULATIONS
2. IMPROVE YOUR FIELD & PLATE MECHANICS
3. JOIN THE LITTLE LEAGUE® UMPIRE REGISTRY!

It's Easy, Register Online Today at LittleLeague.org/Umpires



UMPIRE REGISTRY FREE MEMBERSHIP

INCLUDES

- A Little League® Official Umpire Registry Membership Card
- A Little League® Umpire Registry Certificate
- Access to the Little League Umpire Registry Website
- Discount on Regional Clinics & Schools
- Rules & Instructions Manual (RIM)
- Umpire Clinic Instruction Manual
- 5 Webinars throughout the year

ONLINE ONLY: FREE!



UMPIRE ESSENTIALS BUNDLE

Item # Umpessb

INCLUDES

- 1 Little League Baseball® Rulebook, Item #135
- 1 Little League Softball® Rulebook, Item #145
- 1 Right Call Publication, Item #125
- 1 Bat gauge, Item #972
- 1 Umpire Patch, Item #52A
- 1 Indicator, Item #89401
- Free Shipping on this bundle on

ONLINE ONLY: \$19.99

Available on LittleLeagueStore.net

Should you have any questions, or need information regarding the Umpire Registry, please contact

Cathy Lusk, at 570-326-1921, ext. 2248 or clusk@littleleague.org



The Training Destination for Little League
VOLUNTEERS, PARENTS, COACHES, AND MORE!
LittleLeagueU.org



LITTLE LEAGUE® BASEBALL AND SOFTBALL
RULES INSTRUCTION MANUAL
PREPARED FOR THE 2018 LITTLE LEAGUE UMPIRE SCHOOLS

